

THE COLLECTION

2018/2019

HC28 Cosmo

都汇里

HC28 Cosmo

HC28 都汇里, 用“极简”的语言, 重塑“奢华”的维度, 与众多国际设计大师 Christophe Delcourt, Yonoh, 梁志天 Steve Leung, Roderick Vos, Archirivolto 等, 以新鲜圆润的语言, 复合的色彩和材质, 以及国际化水准的精湛工艺, 创造出大气多元, 有机雅致和时尚有趣的现代家具系列, 并以突破性的视角和思路, 诠释当下和未来都会里的生活方式。

HC28 COSMOPOLITAN is a unique brand reinterpreting luxury in minimalist style. Collaborating with renowned designers like Christophe Delcourt, Yonoh, Steve Leung, Roderick Vos and Archirivolto, the brand has developed a versatile, sophisticated, fresh and relaxing furniture collection. By its smooth and organic elements, sophisticated colors and materials, and its refined quality, the brand represents present and future lifestyles in metropolis.



INDEX

目录

SOFA	沙发	01
ARMCHAIR	扶手椅	19
COFFEE TABLE	茶几	24
SIDE TABLE	边几	29
CONSOLE	条案	34
LIVING CABINET	电视柜	35
DINING TABLE	餐桌	37
CHAIR	椅子	42
SIDEBOARD	餐边柜	47
BED & BEDSIDE TABLE	床 & 床头柜	51
DESK & BOOKCASE	书桌 & 书架	58
ACCESSORY	配饰	59
RUG	地毯	60



SOFA

沙发



NEST 巢
Roderick Vos



尺寸: 1160*912*720mm
1960*912*720mm
2360*912*720mm
编号: 31F014

框架结构: 框架为实木与多层板结构, 金属沙发底脚 / **饰面:** 主体为软包面料, 黑色烤漆金属底脚 / **坐垫软包:** 坐垫为高弹海绵复合, 最上层为蓬松棉填充 / **面料:** 沙发套不可拆卸, 指定弹性面料, 颜色可选 / **靠包:** 没有靠包

STRUCTURE: Structure in solid wood and plywood, feet in metal / **FINISHING:** Upholstered with fabric, feet in black lacquered metal / **SEAT CUSHION:** Seat cushion in high density foam polyurethane and dacron / **COVERING:** Non-removable covering in elastic fabric / **CUSHIONS:** No cushions

ROUND 日月

Yonoh

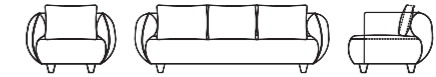

尺寸: 1020*950*680mm
1920*950*680mm
2220*950*680mm
编号: 31F005

框架结构: 框架为实木与多层板结构 / **饰面:** 沙发整体为软包面料或牛皮, 地脚为白色或黑色丝光烤漆 / **坐垫软包:** 坐垫为高弹海绵复合, 最上层为蓬松棉填充 / **面料:** 沙发套不可拆卸, 多种面料或牛皮可选 / **靠包:** 珍珠棉和鹅绒混合填充, 纯棉靠包内套, 外套为可拆卸的面料或牛皮套

STRUCTURE: Structure in solid wood and plywood / **FINISHING:** Upholstered with fabric or leather, legs in silk white or black lacquer / **SEAT CUSHION:** Seat cushion in high density foam polyurethane and dacron / **COVERING:** Non-removable covering in fabric or leather / **CUSHIONS:** Polyester padding and goose down with cotton pre-covering, removable covering in fabric or leather

BOL 元阳

Christophe Delcourt



尺寸: 1020*835*632mm
2000*835*632mm
2250*835*632mm
编号: 31F004

框架结构: 框架为实木与多层板结构 / **饰面:** 主体为软包面料, 底座为胡桃木或染色橡木 / **坐垫软包:** 坐垫为高弹海绵复合, 最上层为蓬松棉填充 / **面料:** 沙发套不可拆卸, 多种面料可选 / **靠包:** 珍珠棉和鹅绒混合填充, 纯棉靠包内套, 外套为可拆卸的面料

STRUCTURE: Structure in solid wood and plywood / **FINISHING:** Upholstered with fabric, base in natural walnut or stained oak / **SEAT CUSHION:** Seat cushion in high density foam polyurethane and dacron / **COVERING:** Non-removable covering in fabric / **CUSHIONS:** Polyester padding and goose down with cotton pre-covering, removable covering in fabric

CITTI 西提

Frank Chou 周宸宸



尺寸: 1714*870*820mm
2254*870*820mm
3334*870*820mm
编号: 31F001

框架结构: 框架为实木与多层板结构 / **饰面:** 主体为软包面料或皮, 底座为木质金色烤漆 / **坐垫软包:** 坐垫为高弹海绵复合, 最上层为蓬松棉填充 / **面料:** 沙发套不可拆卸, 多种面料或牛皮可选 / **靠包:** 珍珠棉和鹅绒混合填充, 纯棉靠包内套, 外套为可拆卸的面料或牛皮套

STRUCTURE: Structure in solid wood and plywood / **FINISHING:** Upholstered with fabric or leather, wood base in gold lacquer / **SEAT CUSHION:** Seat cushion in high density foam polyurethane and dacron / **COVERING:** Non-removable covering in fabric or leather / **CUSHIONS:** Polyester padding and goose down with cotton pre-covering, removable covering in fabric or leather

HAP 哈伯

Christophe Delcourt

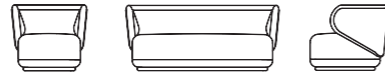

尺寸: 780*790*680mm
1600*810*680mm
2000*810*680mm
编号: 31F013

框架结构: 框架为实木与多层板结构, 木质底座 / **饰面:** 沙发主体为软包面料或皮, 内侧和外侧的选择可不同, 金色烤漆底座 / **坐垫软包:** 坐垫为高弹海绵复合, 最上层为蓬松棉填充 / **面料:** 沙发套不可拆卸, 多种面料或牛皮可选 / **靠包:** 没有靠包

STRUCTURE: Structure in solid wood and plywood, base in wood / **FINISHING:** Upholstered with fabric and/or leather, and the options can be different for inside and outside of the back and arms, base in gold lacquer / **SEAT CUSHION:** Seat cushion in high density foam polyurethane and dacron / **COVERING:** Non-removable covering in fabric or leather / **CUSHIONS:** No cushions

LONJA 龙佳

Santiago Sevillano



尺寸: 1800*880*770mm
2200*880*770mm
编号: 31F003

框架结构: 框架为实木与多层板结构, 金属底座 / **饰面:** 沙发主体为软包面料, 底座为黑色丝光烤漆金属或者香槟金镀钛不锈钢 / **坐垫软包:** 坐垫为高弹海绵复合, 最上层为蓬松棉和羽绒填充 / **面料:** 沙发套不可拆卸, 多种面料可选 / **靠包:** 珍珠棉和羽绒混合填充, 纯棉靠包内套, 外套为可拆卸的面料套

STRUCTURE: Structure in solid wood and plywood, base in metal / **FINISHING:** Upholstered with fabric, base in silk black lacquered metal or champagne titanium plating stainless steel / **SEAT CUSHION:** Seat cushion in high density foam polyurethane, dacron and feather / **COVERING:** Non-removable covering in fabric / **CUSHIONS:** Polyester padding and goose down with cotton pre-covering, removable covering in fabric

LONJA 龙佳

Santiago Sevillano



组合沙发 SECTIONAL SOFA

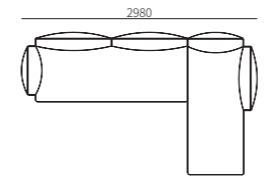

尺寸: 2980*1800*770mm
编码: 31F003ZH-01

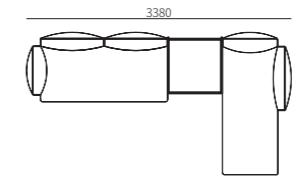

尺寸: 3380*1800*770mm
编码: 31F003ZH-02

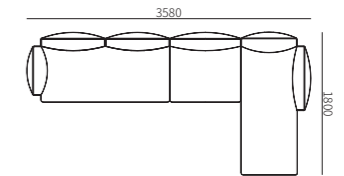

尺寸: 3580*1800*770mm
编码: 31F003ZH-03

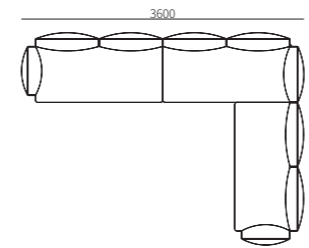

尺寸: 3600*2680*770mm
编码: 31F003ZH-04

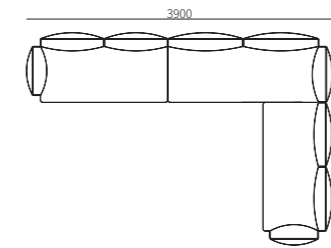

尺寸: 3900*2680*770mm
编码: 31F003ZH-05

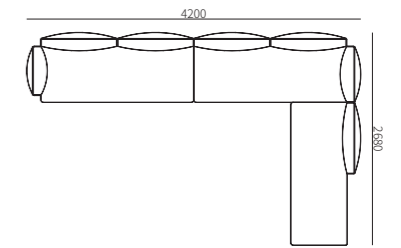

尺寸: 4200*2680*770mm
编码: 31F003ZH-06

单扶 LEFT/RIGHT ONE-ARMED SOFA

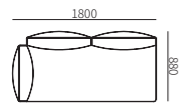

尺寸: 1800*880*770mm
编码: 31F003-21

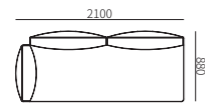

尺寸: 2100*880*770mm
编码: 31F003-22

单背 SIDE TABLE

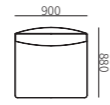

尺寸: 900*880*770mm
编码: 31F003-31

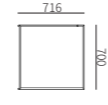

尺寸: 716*700*380mm
编码: 31F003-51

转角 LEFT/RIGHT CHAISE

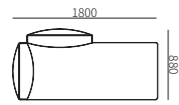

尺寸: 1800*880*770mm
编码: 31F003-41

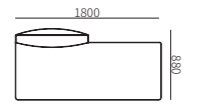

尺寸: 1800*880*770mm
编码: 31F003-42

角位 LEFT/RIGHT CORNER SEAT

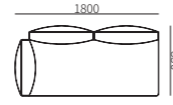

尺寸: 1800*880*770mm
编码: 31F003-61

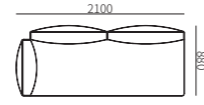

尺寸: 2100*880*770mm
编码: 31F003-62

UOVO 源
Steve Leung 梁志天



尺寸: 2200*1000*755mm
2600*1000*755mm
2800*1000*755mm
编号: 31F006

框架结构: 框架为实木与多层板结构, 金属底脚 / **饰面:** 沙发整体为软包面料或皮, 底脚为黑色丝光烤漆金属 / **坐垫软包:** 坐垫为高弹海绵复合, 最上层为蓬松棉填充 / **面料:** 沙发套不可拆卸, 多种面料或牛皮可选 / **靠包:** 珍珠棉和羽绒混合填充, 纯棉靠包内套, 外套为可拆卸的面料或牛皮套

STRUCTURE: Structure in solid wood and plywood, base in metal / **FINISHING:** Upholstered with fabric or leather, feet in silk black lacquered metal / **SEAT CUSHION:** Seat cushion in high density foam polyurethane and dacron / **COVERING:** Non-removable covering in fabric or leather / **CUSHIONS:** Polyester padding and goose down with cotton pre-covering, removable covering in fabric or leather



沙发 SOFA

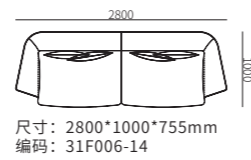
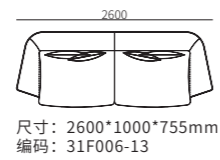

单扶 LEFT/RIGHT ONE-ARMED SOFA

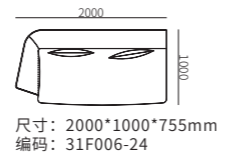
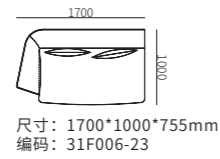
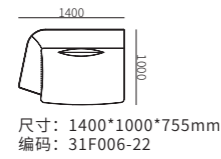

单背 SOFA WITHOUT ARM

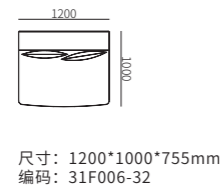

转角 LEFT/RIGHT CHAISE

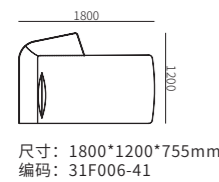

角位 LEFT/RIGHT CORNER SEAT



组合沙发 SECTIONAL SOFA

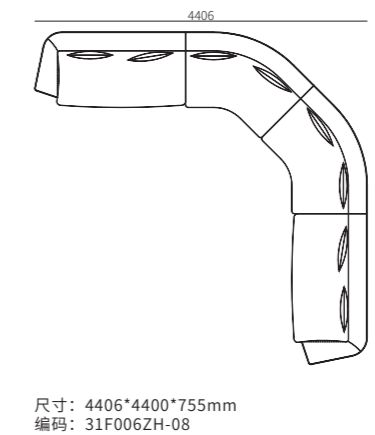
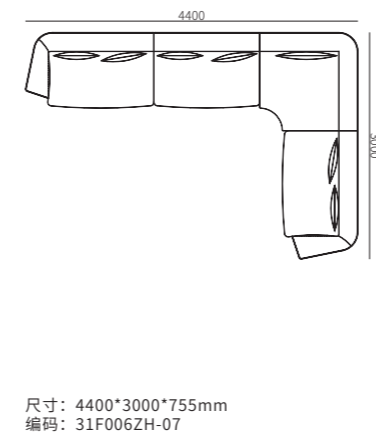
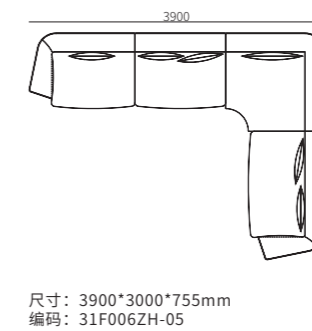
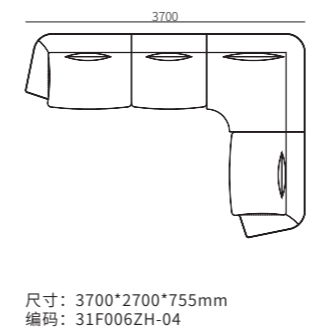
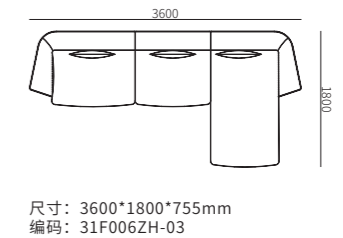

FIL 风尚
Yonoh



编号: 31F011

框架结构: 框架为实木与多层板结构, 金属底脚 / 饰面: 主体为软包面料或皮, 底部金属圆柱黑丝光烤漆 / 坐垫软包: 坐垫为高弹海绵复合, 最上层为蓬松棉填充 / 面料: 沙发套不可拆卸, 多种面料或牛皮可选 / 靠包: 珍珠棉和羽绒混合填充, 纯棉靠包内套, 外套为可拆卸的面料或牛皮套

STRUCTURE: Structure in solid wood and plywood, feet in metal / FINISHING: Upholstered with fabric or leather, feet in silk black lacquered metal / SEAT CUSHION: Seat cushion in high density foam polyurethane and dacron / COVERING: Non-removable covering in fabric or leather / CUSHIONS: Polyester padding and goose down with cotton pre-covering, removable covering in fabric or leather

沙发 SOFA

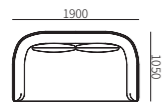

尺寸: 1900*1050*680mm
编码: 31F011-12

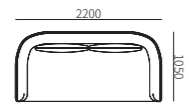

尺寸: 2200*1050*680mm
编码: 31F011-13

单扶 LEFT/RIGHT ONE-ARMED SOFA

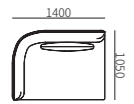

尺寸: 1400*1050*680mm
编码: 31F011-21

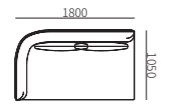

尺寸: 1800*1050*680mm
编码: 31F011-22

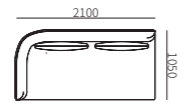

尺寸: 2100*1050*680mm
编码: 31F011-23

转角 LEFT/RIGHT CHAISE

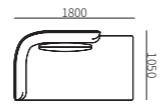

尺寸: 1800*1050*680mm
编码: 31F011-41

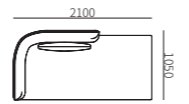

尺寸: 2100*1050*680mm
编码: 31F011-42

单背 SOFA WITHOUT ARM

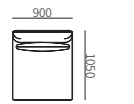

尺寸: 900*1050*680mm
编码: 31F011-31

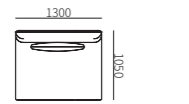

尺寸: 1300*1050*680mm
编码: 31F011-32

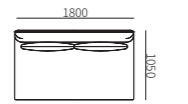

尺寸: 1800*1050*680mm
编码: 31F011-33

墩 OTTOMAN

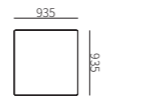

尺寸: 935*935*400mm
编码: 31F011-51

角位 LEFT/RIGHT CORNER SEAT

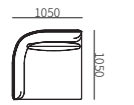

尺寸: 1050*1050*680mm
编码: 31F011-61

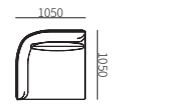

尺寸: 1050*1050*880mm
编码: 31F011-62

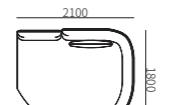

尺寸: 2100*1800*880mm
编码: 31F011-63

组合沙发 SECTIONAL SOFA

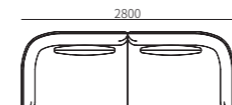

尺寸: 2800*1050*680mm
编码: 31F011ZH-01



尺寸: 3150*1800*680mm
编码: 31F011ZH-02

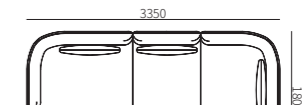

尺寸: 3350*1800*680mm
编码: 31F011ZH-03

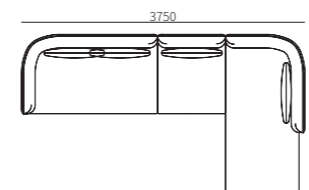

尺寸: 3750*2100*680mm
编码: 31F011ZH-04

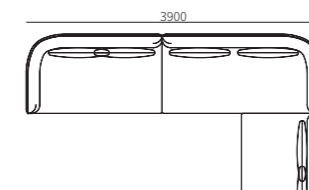

尺寸: 3900*2850*680mm
编码: 31F011ZH-05

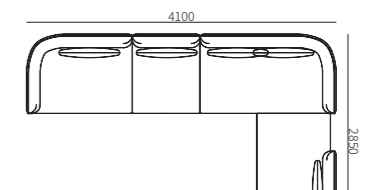

尺寸: 4100*2850*680mm
编码: 31F011ZH-06

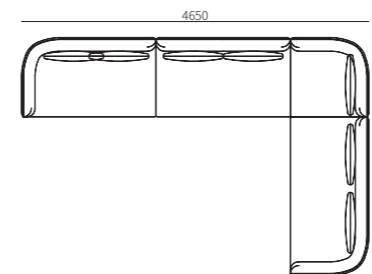

尺寸: 4650*3150*680mm
编码: 31F011ZH-07

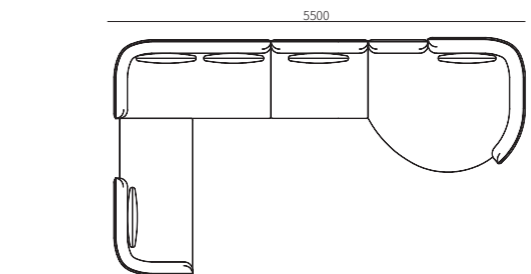

尺寸: 5500*3150*680mm
编码: 31F011ZH-08

MICHEL 米其

Yonoh



编号: 31F009

框架结构: 框架为实木与多层板结构, 金属底架 / **饰面:** 主体为软包面料或皮, 底座为金属黑色丝光烤漆 / **坐垫软包:** 坐垫为高弹海绵复合, 最上层为蓬松棉填充 / **面料:** 沙发套不可拆卸, 多种面料或牛皮可选 / **靠包:** 珍珠棉和羽绒混合填充, 纯棉靠包内套, 外套为可拆卸的面料或牛皮套

STRUCTURE: Structure in solid wood and plywood, base in metal / **FINISHING:** Upholstered with fabric or leather, base in silk black lacquered metal / **SEAT CUSHION:** Seat cushion in high density foam polyurethane and dacron / **COVERING:** Non-removable covering in fabric or leather / **CUSHIONS:** Polyester padding and goose down with cotton pre-covering, removable covering in fabric or leather

沙发 SOFA

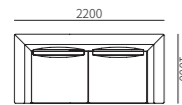

尺寸: 2200*1000*680mm
编码: 31F009-13

单扶 LEFT/RIGHT ONE-ARMED SOFA

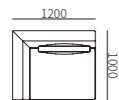

尺寸: 1200*1000*680mm
编码: 31F009-21

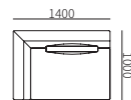

尺寸: 1400*1000*680mm
编码: 31F009-22

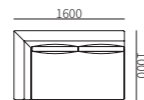

尺寸: 1600*1000*680mm
编码: 31F009-23

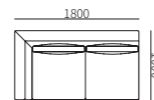

尺寸: 1800*1000*680mm
编码: 31F009-24

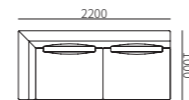

尺寸: 2200*1000*680mm
编码: 31F009-25

单背 SOFA WITHOUT ARM

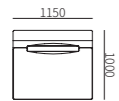

尺寸: 1150*1000*680mm
编码: 31F009-31

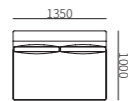

尺寸: 1350*1000*680mm
编码: 31F009-32

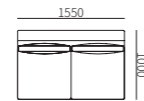

尺寸: 1550*1000*680mm
编码: 31F009-33

角位 LEFT/RIGHT CORNER SEAT

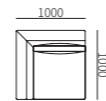

尺寸: 1000*1000*680mm
编码: 31F009-61

墩 OTTOMAN

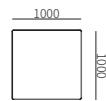

尺寸: 1000*1000*400mm
编码: 31F009-51

转角 LEFT/RIGHT CHAISE

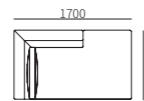

尺寸: 1700*1000*680mm
编码: 31F009-41

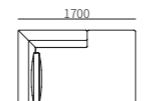

尺寸: 1700*1200*680mm
编码: 31F009-42

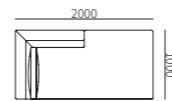

尺寸: 2000*1000*680mm
编码: 31F009-43

组合沙发 SECTIONAL SOFA

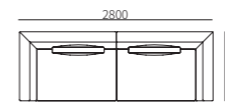

尺寸: 2800*1000*680mm
编码: 31F009ZH-02

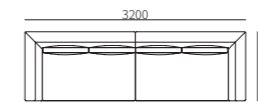

尺寸: 3200*1000*680mm
编码: 31F009ZH-03

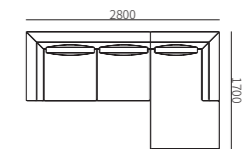

尺寸: 2800*1700*680mm
编码: 31F009ZH-04

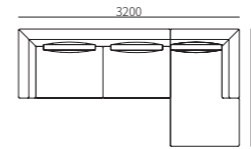

尺寸: 3200*1700*680mm
编码: 31F009ZH-05

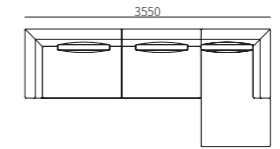

尺寸: 3550*1700*680mm
编码: 31F009ZH-06

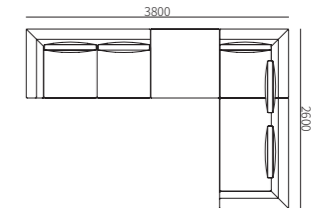

尺寸: 3800*2600*680mm
编码: 更多组合

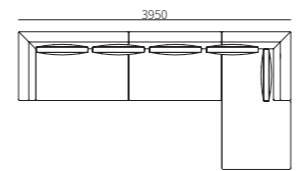

尺寸: 3950*2000*680mm
编码: 31F009ZH-07

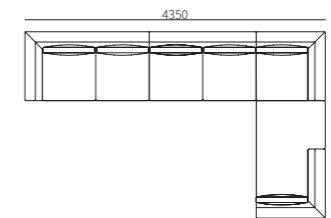

尺寸: 4350*2700*680mm
编码: 31F009ZH-08

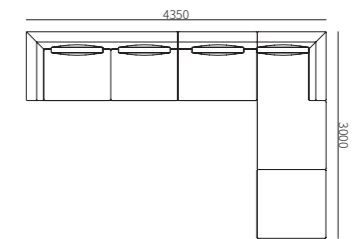

尺寸: 4350*3000*680mm
编码: 31F009ZH-09

EVERGREEN 常青
L.L Studio



编号: 31F012

框架结构: 框架为实木与多层板结构, 金属底脚 / 饰面: 主体为软包面料或皮, 底脚为黑色丝光烤漆 / 坐垫软包: 坐垫为高弹海绵复合, 最上层为蓬松棉和羽绒填充 / 面料: 沙发套不可拆卸, 多种面料或牛皮可选 / 靠包: 珍珠棉和羽绒混合填充, 纯棉靠包内套, 外套为可拆卸的面料或牛皮套

STRUCTURE: Structure in solid wood and plywood, legs in metal / FINISHING: Upholstered with fabric or leather, legs in silk black lacquered metal / SEAT CUSHION: Seat cushion in high density foam polyurethane, dacron and feather / COVERING: Non-removable covering in fabric or leather / CUSHIONS: Polyester padding and goose down with cotton pre-covering, removable covering in fabric or leather

沙发 SOFA

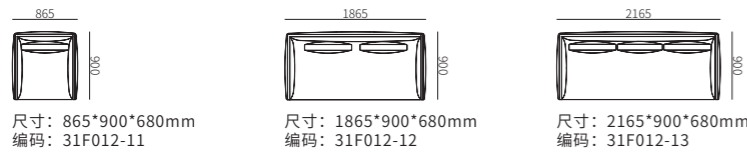

尺寸: 865*900*680mm
编码: 31F012-11

尺寸: 1865*900*680mm
编码: 31F012-12

尺寸: 2165*900*680mm
编码: 31F012-13

单扶 LEFT/RIGHT ONE-ARMED SOFA



尺寸: 1400*900*680mm
编码: 31F012-21

尺寸: 1600*900*680mm
编码: 31F012-22

尺寸: 1900*900*680mm
编码: 31F012-23

尺寸: 2100*900*680mm
编码: 31F012-24

单背 SOFA WITHOUT ARM

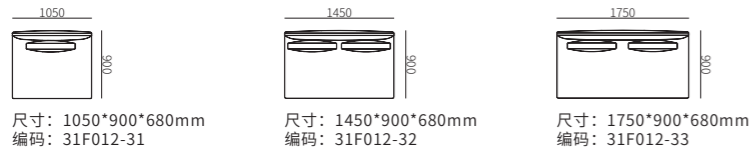

尺寸: 1050*900*680mm
编码: 31F012-31

尺寸: 1450*900*680mm
编码: 31F012-32

尺寸: 1750*900*680mm
编码: 31F012-33

转角 LEFT/RIGHT CHAISE

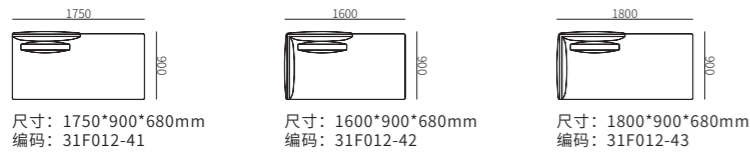

尺寸: 1750*900*680mm
编码: 31F012-41

尺寸: 1600*900*680mm
编码: 31F012-42

尺寸: 1800*900*680mm
编码: 31F012-43

墩 OTTOMAN



尺寸: 870*870*380mm
编码: 31F012-51

组合沙发 SECTIONAL SOFA

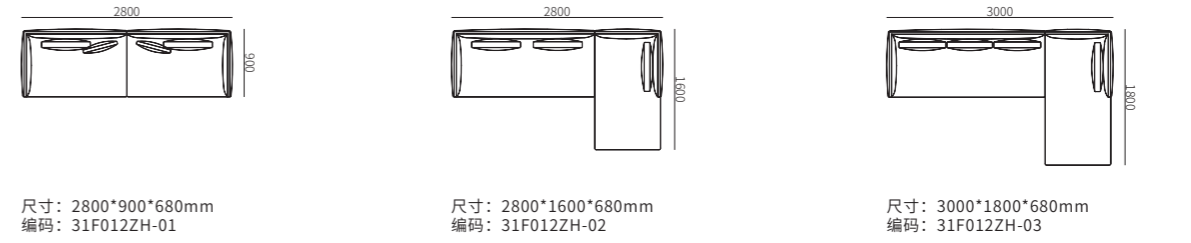

尺寸: 2800*900*680mm
编码: 31F012ZH-01

尺寸: 2800*1600*680mm
编码: 31F012ZH-02

尺寸: 3000*1800*680mm
编码: 31F012ZH-03

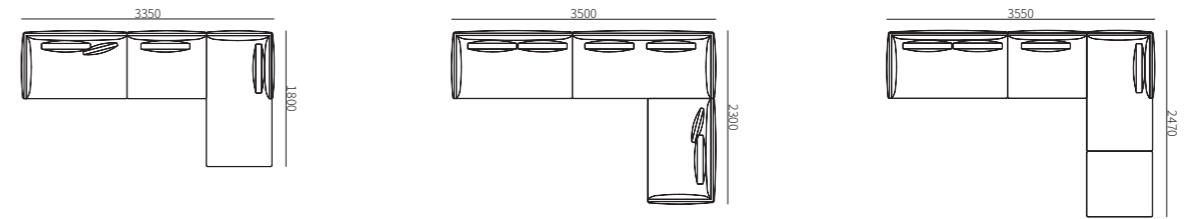

尺寸: 3350*1800*680mm
编码: 31F012ZH-04

尺寸: 3500*2300*680mm
编码: 31F012ZH-05

尺寸: 3550*2470*680mm
编码: 31F012ZH-06

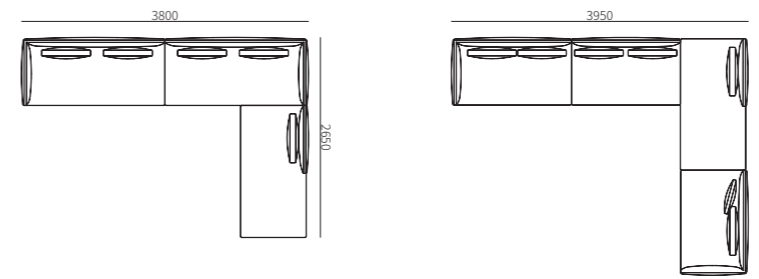

尺寸: 3800*2650*680mm
编码: 31F012ZH-07

尺寸: 3950*3150*680mm
编码: 31F012ZH-08

FOLIA 红叶

Yonoh



编号: 31F007

框架结构: 框架为实木与多层板结构 / 饰面: 沙发整体为软包面料, 地脚为金属黑丝光烤漆 / 坐垫软包: 坐垫为高弹海绵复合, 最上层为蓬松棉填充 / 面料: 沙发套不可拆卸, 多种面料可选 / 靠包: 珍珠棉和鹅绒混合填充, 纯棉靠包内套, 外套为可拆卸的面料

STRUCTURE: Structure in solid wood and plywood / FINISHING: Upholstered with fabric, legs in silk black lacquered metal / SEAT CUSHION: Seat cushion in high density foam polyurethane and dacron / COVERING: Non-removable covering in fabric / CUSHIONS: Polyester padding and goose down with cotton pre-covering, removable covering in fabric

单扶 LEFT/RIGHT ONE-ARMED SOFA

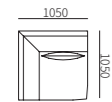

尺寸: 1050*1050*715mm
编码: 31F007-21

单背 SOFA WITHOUT ARM

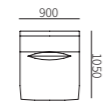

尺寸: 900*1050*715mm
编码: 31F007-31

墩 OTTOMAN

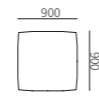

尺寸: 900*900*405mm
编码: 31F007-51

组合沙发 SECTIONAL SOFA

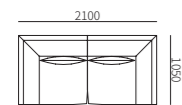

尺寸: 2100*1050*715mm
编码: 31F007ZH-01

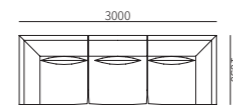

尺寸: 3000*1050*715mm
编码: 31F007ZH-02

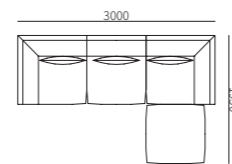

尺寸: 3000*1950*715mm
编码: 31F007ZH-03

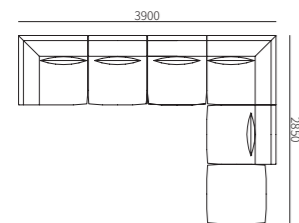

尺寸: 3900*2850*715mm
编码: 31F007ZH-04

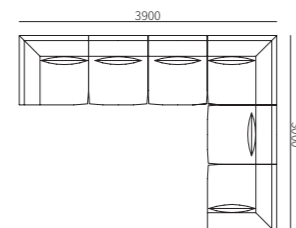

尺寸: 3900*3000*715mm
编码: 31F007ZH-05

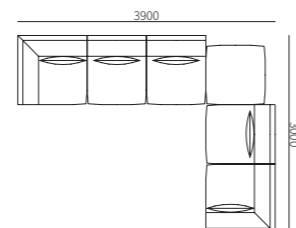

尺寸: 3900*3000*715mm
编码: 31F007ZH-06

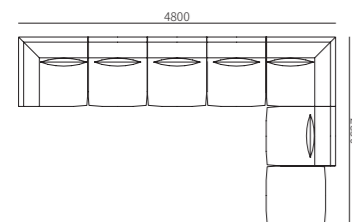

尺寸: 4800*2850*715mm
编码: 31F007ZH-07



QUADRA 嘉里

Yonoh



编号: 31F008

框架结构: 框架为实木与多层板结构, 不锈钢底架 / **饰面:** 主体为软包面料或皮, 底座为黑镜钛 / **坐垫软包:** 坐垫为高弹海绵复合, 最上层为蓬松棉和羽绒填充 / **面料:** 沙发套可拆卸, 多种面料或牛皮可选 / **靠包:** 珍珠棉和鹅绒混合填充, 纯棉靠包内套, 外套为可拆卸的面料或牛皮套

STRUCTURE: Structure in solid wood and plywood, base in stainless steel / **FINISHING:** Upholstered with fabric or leather, base in black titanium / **SEAT CUSHION:** Seat cushion in high density foam polyurethane, dacron and feather / **COVERING:** Removable covering in fabric or leather / **CUSHIONS:** Polyester padding and goose down with cotton pre-covering, removable covering in fabric or leather

沙发 SOFA

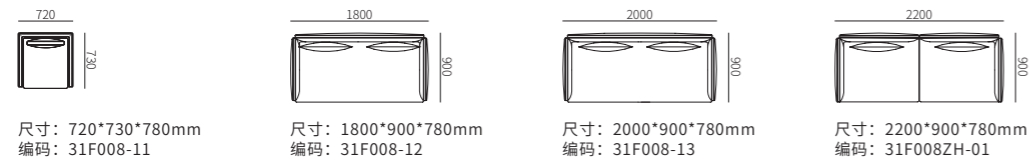

单扶 LEFT/RIGHT ONE-ARMED SOFA

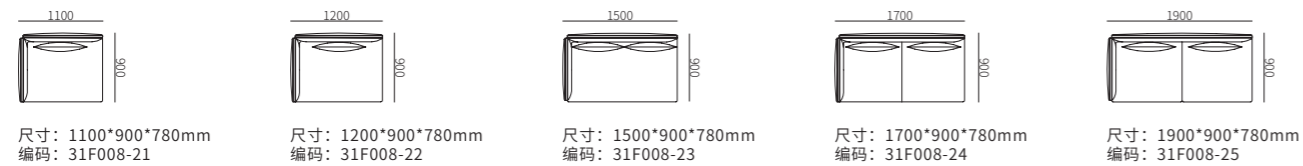

单背 SOFA WITHOUT ARM



角位 LEFT/RIGHT CORNER SEAT

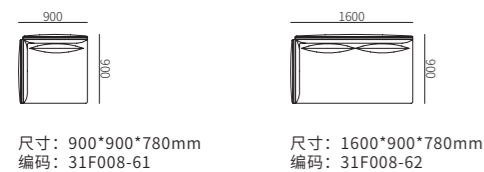

转角 LEFT/RIGHT CHAISE

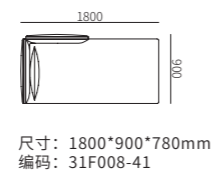

组合沙发 SECTIONAL SOFA

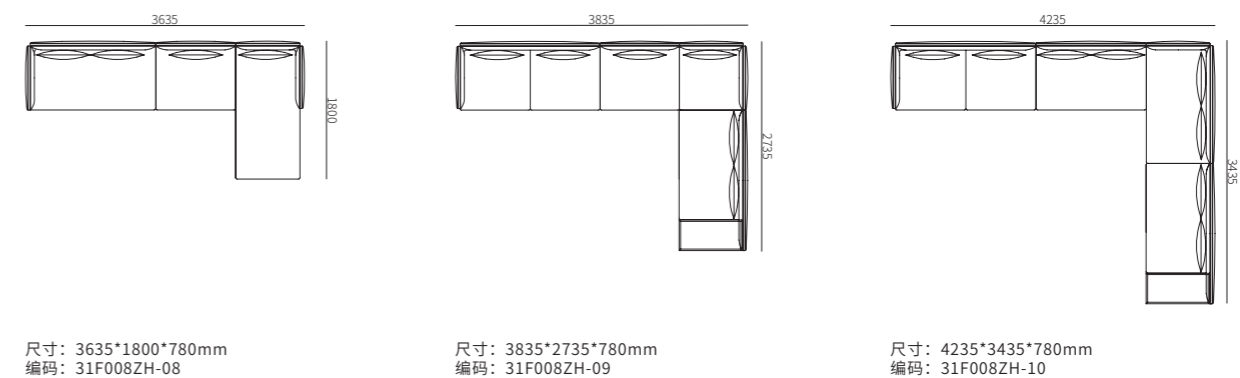
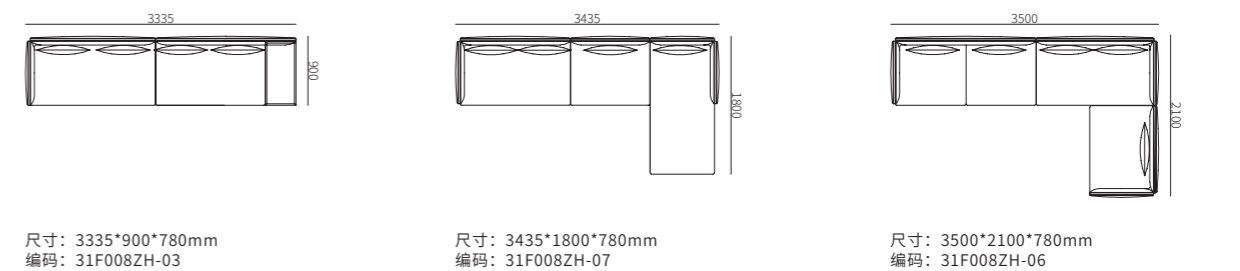
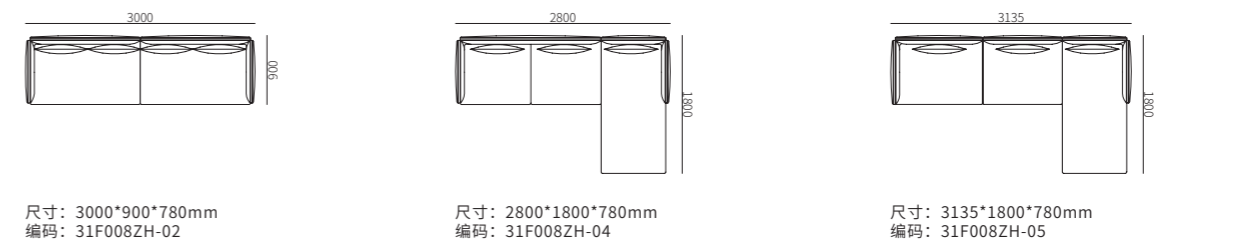



ARMCHAIR

单人位



CALA 朵朵
Yonoh

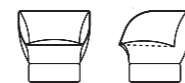

尺寸: 700*700*710mm
编号: 32F004

结构: 框架为金属, PU 发泡一次成型, 座位带转盘 / 表面效果: 沙发整体为软包面料或皮 / 坐垫: 坐垫为高弹海绵复合, 上层为蓬松棉填充

STRUCTURE: Structure in metal and shaped polyurethane foam, swivel base / FINISHING: Upholstered with fabric or leather / SEAT: Seat cushion in high density foam polyurethane and dacron

GIO 山谷
Christophe Delcourt

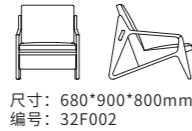

尺寸: 680*900*800mm
编号: 32F002

结构: 框架为实木与多层板结构 / **表面效果:** 主体为软包面料或皮, 底座为黑色亮光烤漆 / **坐垫:** 坐垫为高弹海绵复合, 上层为蓬松棉填充
STRUCTURE: Structure in solid wood and plywood / **FINISHING:** Upholstered with fabric or leather, base in black lacquered solid wood / **SEAT:** Seat cushion in high density foam polyurethane and dacron

LOVY 洛维
Frank Chou 周宸宸



尺寸: 640*700*770mm
编号: 32F001

结构: 框架为金属, 主体 PU 发泡一次成型, 椅腿为金属 / **表面效果:** 主体为软包面料, 底座为金属黑丝光烤漆, 金色地脚 / **坐垫:** 坐垫为高弹海绵复合, 上层为蓬松棉填充
STRUCTURE: Structure in metal and shaped polyurethane foam, legs in metal / **FINISHING:** Upholstered with fabric, base in silk black lacquered metal, feet in gold titanium stainless steel / **SEAT:** Seat cushion in high density foam polyurethane and dacron

STRUCTURE: Structure in metal and shaped polyurethane foam, legs in metal / **FINISHING:** Upholstered with fabric, base in silk black lacquered metal, feet in gold titanium stainless steel / **SEAT:** Seat cushion in high density foam polyurethane and dacron

CACTUS 仙人掌
Archirivolto



尺寸: 616*712*720mm
编号: 32F010

结构: 框架为实木与多层板结构, 不锈钢底架 / **表面效果:** 主体为软包面料或皮, 底座为不锈钢香槟金电镀 / **坐垫:** 坐垫为高弹海绵复合, 上层为蓬松棉填充
STRUCTURE: Structure in solid wood and plywood, legs in stainless steel / **FINISHING:** Upholstered with fabric or leather, legs in champagne titanium plating stainless steel / **SEAT:** Seat cushion in high density foam polyurethane and dacron

STRUCTURE: Structure in solid wood and plywood, legs in stainless steel / **FINISHING:** Upholstered with fabric or leather, legs in champagne titanium plating stainless steel / **SEAT:** Seat cushion in high density foam polyurethane and dacron

CACTUS 仙人掌
Archirivolto



尺寸: 616*712*720mm
编号: 32F009

结构: 框架为实木与多层板结构, 木质底架 / **表面效果:** 主体为软包面料或皮, 底座为胡桃或染色橡木 / **坐垫:** 坐垫为高弹海绵复合, 上层为蓬松棉填充
STRUCTURE: Structure in solid wood and plywood, legs in solid wood / **FINISHING:** Upholstered with fabric or leather, legs in walnut or stained oak / **SEAT:** Seat cushion in high density foam polyurethane and dacron

STRUCTURE: Structure in solid wood and plywood, legs in solid wood / **FINISHING:** Upholstered with fabric or leather, legs in walnut or stained oak / **SEAT:** Seat cushion in high density foam polyurethane and dacron

DIAMANTE 多德
Archirivolto

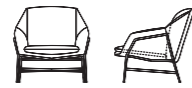

尺寸: 800*780*800mm
编号: 32F007

结构: 框架为实木与多层板结构, 底架为金属 / **表面效果:** 主体为软包面料或皮, 底架为黑灰色氟碳漆, 金色地脚 / **坐垫:** 坐垫为高弹海绵复合, 上层为蓬松棉填充
STRUCTURE: Structure in solid wood and plywood, base in metal / **FINISHING:** Upholstered with fabric and/or leather, base in dark grey epoxy paint, feet in gold titanium stainless steel / **SEAT:** Seat cushion in high density foam polyurethane and dacron

STRUCTURE: Structure in solid wood and plywood, base in metal / **FINISHING:** Upholstered with fabric and/or leather, base in dark grey epoxy paint, feet in gold titanium stainless steel / **SEAT:** Seat cushion in high density foam polyurethane and dacron

UOVO 源
Steve Leung 梁志天



尺寸: 850*850*700mm
编号: 32F006

结构: 框架为实木与多层板结构 / **表面效果:** 主体为软包面料或皮, 底座为胡桃木或染色橡木 / **坐垫:** 坐垫为高弹海绵复合, 上层为蓬松棉填充
STRUCTURE: Structure in solid wood and plywood / **FINISHING:** Upholstered with fabric or leather, base in walnut or stained oak / **SEAT:** Seat cushion in high density foam polyurethane and dacron

STRUCTURE: Structure in solid wood and plywood / **FINISHING:** Upholstered with fabric or leather, base in walnut or stained oak / **SEAT:** Seat cushion in high density foam polyurethane and dacron

POMA 元音
Yonoh



尺寸: 800*850*950mm
编号: 32F003

结构: 框架为实木与多层板结构, 沙发腿为实木 / **表面效果:** 主体为软包面料或皮, 内侧和外侧的选择可不同, 底座为胡桃或染色橡木 / **坐垫:** 坐垫为高弹海绵复合, 上层为蓬松棉填充
STRUCTURE: Structure in solid wood and plywood, legs in solid wood / **FINISHING:** Upholstered with fabric or leather, and the options can be different for inside and outside of the back, legs in walnut or stained oak / **SEAT:** Seat cushion in high density foam polyurethane and dacron

STRUCTURE: Structure in solid wood and plywood, legs in solid wood / **FINISHING:** Upholstered with fabric or leather, and the options can be different for inside and outside of the back, legs in walnut or stained oak / **SEAT:** Seat cushion in high density foam polyurethane and dacron

POMA 元音
Yonoh

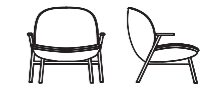

尺寸: 745*767*795mm
编号: 32F008

结构: 框架为实木与多层板结构, 沙发腿为实木 / **表面效果:** 主体为软包面料或皮, 内侧和外侧的选择可不同, 底座为胡桃或染色橡木 / **坐垫:** 坐垫为高弹海绵复合, 上层为蓬松棉填充
STRUCTURE: Structure in solid wood and plywood, legs in solid wood / **FINISHING:** Upholstered with fabric or leather, and the options can be different for inside and outside of the back, legs in walnut or stained oak / **SEAT:** Seat cushion in high density foam polyurethane and dacron

STRUCTURE: Structure in solid wood and plywood, legs in solid wood / **FINISHING:** Upholstered with fabric or leather, and the options can be different for inside and outside of the back, legs in walnut or stained oak / **SEAT:** Seat cushion in high density foam polyurethane and dacron

ROUND 日月
Yonoh

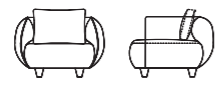

尺寸: 1020*950*680mm
编号: 31F005-11

结构: 框架为实木与多层板结构, 木质底脚 / **表面效果:** 沙发整体为软包面料或牛皮, 底脚为白色丝光或者黑色烤漆 / **坐垫:** 坐垫为高弹海绵复合, 最上层为蓬松棉填充
STRUCTURE: Structure in solid wood and plywood, legs in wood / **FINISHING:** Upholstered with fabric or leather, legs in silk white or black lacquer / **SEAT:** Seat cushion in high density foam polyurethane and dacron

STRUCTURE: Structure in solid wood and plywood, legs in wood / **FINISHING:** Upholstered with fabric or leather, legs in silk white or black lacquer / **SEAT:** Seat cushion in high density foam polyurethane and dacron

BOL 元阳
Christophe Delcourt

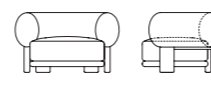

尺寸: 1020*835*632mm
编号: 31F004-11

结构: 框架为实木与多层板结构 / **表面效果:** 主体为软包面料, 底座为胡桃木或染色橡木 / **坐垫:** 坐垫为高弹海绵复合, 上层为蓬松棉填充
STRUCTURE: Structure in solid wood and plywood / **FINISHING:** Upholstered with fabric, base in walnut or stained oak / **SEAT:** Seat cushion in high density foam polyurethane and dacron

STRUCTURE: Structure in solid wood and plywood / **FINISHING:** Upholstered with fabric, base in walnut or stained oak / **SEAT:** Seat cushion in high density foam polyurethane and dacron

HAP 哈伯
Christophe Delcourt

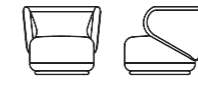

尺寸: 780*790*680mm
编号: 31F013-11

结构: 框架为实木与多层板结构, 木质底座, 座位带转盘 / **表面效果:** 主体为软包面料或皮, 内侧和外侧的选择可不同, 底座为木质金色烤漆 / **坐垫:** 坐垫为高弹海绵复合, 上层为蓬松棉填充
STRUCTURE: Structure in solid wood and plywood, base in wood, swivel base / **FINISHING:** Upholstered with fabric and/or leather, and the options can be different for inside and outside of the back and arms, wood base in gold lacquer / **SEAT:** Seat cushion in high density foam polyurethane and dacron

STRUCTURE: Structure in solid wood and plywood, base in wood, swivel base / **FINISHING:** Upholstered with fabric and/or leather, and the options can be different for inside and outside of the back and arms, wood base in gold lacquer / **SEAT:** Seat cushion in high density foam polyurethane and dacron

QUADRA 嘉里
Yonoh



尺寸: 720*730*780mm
编号: 31F008-11

结构: 框架为实木与多层板结构, 底架为不锈钢 / **表面效果:** 主体为软包面料或皮, 底座为黑镜电镀钛不锈钢 / **坐垫:** 坐垫为高弹海绵复合, 上层为蓬松棉填充
STRUCTURE: Structure in solid wood and plywood, base in stainless steel / **FINISHING:** Upholstered with fabric or leather, base in black titanium plating stainless steel / **SEAT:** Seat cushion in high density foam polyurethane and dacron

STRUCTURE: Structure in solid wood and plywood, base in stainless steel / **FINISHING:** Upholstered with fabric or leather, base in black titanium plating stainless steel / **SEAT:** Seat cushion in high density foam polyurethane and dacron

UOVO 源
Steve Leung 梁志天



尺寸: 620*890*950mm
编号: 32F005

结构: 主体为玻璃钢烤漆, 底脚为实木 / 表面效果: 主体为软包面料或皮, 外壳为黑色或白色烤漆, 底脚为胡桃木或染色橡木 / 坐垫: 坐垫为高弹海绵复合, 上层为蓬松棉填充

STRUCTURE: Structure in lacquered fiberglass, legs in solid wood / FINISHING: Upholstered with fabric or leather, shell in white or black lacquer, legs in walnut or stained oak / SEAT: Seat cushion in high density foam polyurethane and dacron

UOVO 源
Steve Leung 梁志天



尺寸: 1000*1000*755mm
编号: 31F006-11

结构: 框架为实木与多层板结构, 金属底脚 / 表面效果: 主体为软包面料或皮, 底脚为黑色丝光烤漆金属 / 坐垫: 坐垫为高弹海绵复合, 上层为蓬松棉填充

STRUCTURE: Structure in solid wood and plywood, feet in metal / FINISHING: Upholstered with fabric or leather, feet in silk black lacquered metal / SEAT: Seat cushion in high density foam polyurethane and dacron



COFFEE TABLE

茶几



CRI 可瑞
Archirivolto

尺寸: D1248*335mm D1048*335mm
编号: 41C001

结构: 桌面为大理石, 框架为不锈钢 / 表面效果: 桌面为中花白或杭灰大理石, 框架为香槟金镀钛不锈钢

STRUCTURE: Top in marble, stainless steel frame / FINISHING: Top in venato white marble or charly brown marble, base in champagne titanium plating stainless steel

CRI 可瑞
Archirivolto



尺寸: D1248*335mm
D1048*335mm
编号: 41C002

结构: 桌面为实木及板材贴皮, 框架为不锈钢 / 表面效果: 桌面为胡桃或染色橡木, 框架为香槟金镀钛不锈钢

STRUCTURE: Top in solid wood and veneer on particles board, stainless steel frame / FINISHING: Top in natural walnut or stained oak, base in champagne titanium plating stainless steel

WIST 凯旋
Frank Chou 周宸宸



尺寸: D1200*360mm
D1000*360mm
编号: 41C018

结构: 桌面为烤漆 MDF, 框架为金属 / 表面效果: 桌面为烤漆, 底架为灰黑色氟碳漆底架, 金色镀钛底脚

STRUCTURE: Top in MDF, base in metal / FINISHING: Top in lacquer, base in dark grey epoxy paint with gold titanium feet

FUGUE 富笛
Frank Chou 周宸宸



尺寸: 1400*800*340mm
1200*700*340mm
编号: 41C019

结构: 桌面为大理石, 底部为实木 / 表面效果: 桌面为中花白或者杭灰大理石, 底部为胡桃木或者染色橡木, 或者实木黑色烤漆

STRUCTURE: Top in marble, base in solid wood / FINISHING: Top in venato white marble or charly brown marble, base in walnut or stained oak, or black lacquer solid wood

UOVO 源
Steve Leung 梁志天



尺寸: 1400*1200*320mm
编号: 41C010

结构: 桌面为大理石, 底座为实木 / 表面效果: 桌面为中花白或杭灰大理石, 底座为胡桃木色或染色橡木

STRUCTURE: Top in marble, base in solid wood / FINISHING: Top in venato white marble or charly brown marble, base in walnut or stained oak

MIKO 米可
Archirivolto



尺寸: D800*H440mm
编号: 41C013

结构: 桌面为实木及板材贴皮, 底架为金属 / 表面效果: 桌面为胡桃木或染色橡木, 框架为黑灰色氟碳漆

STRUCTURE: Top in solid wood and veneer on particles board, base in metal / FINISHING: Top in walnut or stained oak, base in dark grey epoxy paint



尺寸: 1400*800*340mm
1200*700*340mm
编号: 41C020

结构: 整体是实木和板材贴皮 / 表面效果: 整体为胡桃木或者染色橡木

STRUCTURE: Whole piece in solid wood and veneer on particles board / FINISHING: Whole piece in walnut or stained oak

LAKE 镜湖
Christophe Delcourt



尺寸: 1300*814*350mm
编号: 41C005

结构: 桌腿为实木, 桌面为烤漆密度板 / 表面效果: 桌面为砚灰色烤漆, 桌腿为胡桃或染色橡木
STRUCTURE: Top in lacquered MDF and legs in solid wood / FINISHING: Top in rock grey lacquer and legs in walnut or stained oak

TILE 泰然
Yonoh

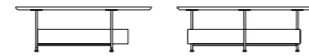

尺寸: D1200*400mm
编号: 41C011/41C012

结构: 桌面为实木及板材贴皮或大理石, 框架为金属 / 表面效果: 桌面为胡桃木或染色橡木, 或中花白或杭灰大理石, 框架为黑灰色氟碳漆, 地脚为金色镀铬
STRUCTURE: Top in solid wood and veneer on particles board or marble, base in metal / FINISHING: Top in walnut or stained oak, or venato white marble or charly brown marble, base in dark grey epoxy paint with gold titanium feet

ONA 融筑
Yonoh

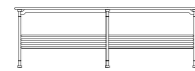
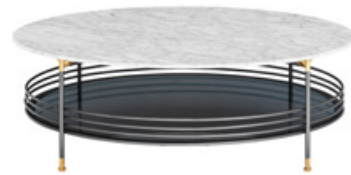

尺寸: D1400*389mm
D1200*389mm
编号: 41C014

结构: 桌面为大理石, 层板为玻璃, 框架为金属 / 表面效果: 桌面为中花白或者杭灰大理石, 层板为灰色钢化玻璃, 框架为黑灰色氟碳漆, 立柱上下为金色镀铬装饰
STRUCTURE: Top in marble, shelf in glass and base in metal / FINISHING: Top in venato white marble or charly brown marble, shelf in grey glass, and frame in dark grey epoxy paint with gold titanium on top and feet of posts

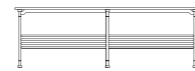

尺寸: D1400*389mm
D1200*389mm
编号: 41C015

结构: 桌面为实木及板材贴皮, 层板为玻璃, 框架为金属 / 表面效果: 桌面为胡桃木或染色橡木, 层板为灰色钢化玻璃, 框架为黑灰色氟碳漆, 立柱上下为金色镀铬装饰
STRUCTURE: Top in solid wood and veneer on particles board, shelf in glass and base in metal / FINISHING: Top in walnut or stained oak, shelf in grey glass, and frame in dark grey epoxy paint with gold titanium on top and feet of posts

TRON 凡云
Yonoh



尺寸: 1400*1088*448mm
1200*1088*448mm
编号: 41C003

结构: 桌面为大理石, 底部为实木及板材贴皮 / 表面效果: 桌面为中花白或杭灰大理石, 底部为胡桃木或染色橡木
STRUCTURE: Top in marble, base in solid wood and veneer on particles board / FINISHING: Top in venato white marble or charly brown marble, base in walnut or stained oak

PLAN 普兰
Archirivolto



尺寸: 1400*1400*373mm
1200*1200*373mm
1000*1000*373mm
编号: 41C009

结构: 整体为实木及板材贴皮, 桌面一侧大理石, 底座为不锈钢 / 表面效果: 整体为胡桃木色或染色橡木, 一侧桌面为中花白或杭灰大理石, 底座为黑色镜面镀铬
STRUCTURE: Whole piece in solid wood and veneer on particles board, one side of the top in marble, stainless steel frame / FINISHING: Whole piece in walnut or stained oak, one side of the top in venato white marble or charly brown marble, base in black titanium



尺寸: 1400*700*373mm
编号: 41C009-04

STRUCTURE: Whole piece in solid wood and veneer on particles board, one side of the top in marble, stainless steel frame / FINISHING: Whole piece in walnut or stained oak, one side of the top in venato white marble or charly brown marble, base in black titanium

PLAN 普兰
Archirivolto



尺寸: 1400*1400*373mm
1200*1200*373mm
1000*1000*373mm
编号: 41C006

结构: 整体为实木及板材贴皮, 底座为不锈钢 / 表面效果: 整体为胡桃木色或染色橡木, 底座为黑色镜面镀铬
STRUCTURE: Whole piece in solid wood and veneer on particles board, stainless steel frame / FINISHING: Whole piece in walnut or stained oak, base in black titanium



尺寸: 1400*700*373mm
编号: 41C006-04

STRUCTURE: Whole piece in solid wood and veneer on particles board, stainless steel frame / FINISHING: Whole piece in walnut or stained oak, base in black titanium

GRAF 林溪
Christophe Delcourt

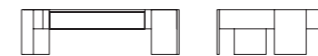

尺寸: 1436*836*350mm
1236*836*350mm
编号: 41C004

结构: 整体为实木及板材贴皮 / 表面效果: 整体为胡桃或染色橡木
STRUCTURE: Whole piece in solid wood and veneer on particles board / FINISHING: Whole piece in walnut or stained oak

GENIE 珍妮
L.L Studio

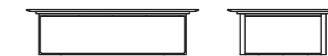

尺寸: 1400*900*382mm
1200*800*382mm
编号: 41C016

尺寸: D600*510mm
编号: 41C017

结构: 大理石桌面、层板实木及板材贴皮、金属下架 / 表面效果: 方茶几桌面为中花白大理石或者杭灰大理石, 圆茶几桌面和方茶几层板胡桃木或染色橡木, 框架为黑灰色氟碳漆
STRUCTURE: Table top in marble, shelf in solid wood and veneer on particles board, frame in metal / FINISHING: Rectangular table top in venato white marble or charly brown marble, round table top and rectangular table shelf in walnut or stained oak, and base in dark grey epoxy paint



SIDE TABLE

边几



ZEN 冰心
Hans Sandgren Jakobsen



尺寸: D354*404mm
编号: 42C003

结构: 整体为不锈钢 / 表面效果: 整体为黑镜镀钛或香槟金镀钛

STRUCTURE: Whole piece in stainless steel / FINISHING: Whole piece in black titanium or champagne titanium

OVO 星空
Christophe Delcourt

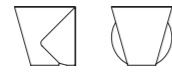

尺寸: 450*450*450mm
编号: 41C007

结构: 整体玻璃钢 / 表面效果: 黑色烤漆主体, 顶圆和侧圆为杉绿色烤漆

STRUCTURE: Whole piece in fiberglass / FINISHING: Whole piece in black lacquer, except one top and one side in patina green lacquer

LOLO 乐乐
L.L Studio

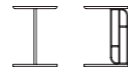

尺寸: D380*515mm
编号: 42C002

结构: 整体为金属 / 表面效果: 整体为香槟金镀钛

STRUCTURE: Whole piece in metal / FINISHING: Whole piece in champagne titanium

TILE 泰然
Yonoh



尺寸: D500*500mm
编号: 41C012

结构: 桌面为实木及板材贴皮, 框架为金属 / 表面效果: 桌面为胡桃木或染色橡木, 框架为黑灰色氟碳漆, 地脚为金色镀钛

STRUCTURE: Top in solid wood and veneer on particles board, base in metal / FINISHING: Top in walnut or stained oak, base in dark grey epoxy paint with gold titanium feet

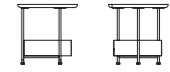

尺寸: D500*500mm
编号: 41C011

结构: 桌面为大理石, 框架为金属 / 表面效果: 桌面为中花白或杭灰大理石, 框架为黑灰色氟碳漆, 地脚为金色镀钛

STRUCTURE: Top in marble, base in metal / FINISHING: Top in venato white marble or charly brown marble, base in dark grey epoxy paint with gold titanium feet

WIST 凯旋
Frank Chou 周宸宸



尺寸: D460*500mm
编号: 41C018

结构: 桌面为烤漆 MDF, 框架为金属 / 表面效果: 桌面为烤漆, 底座为灰黑色氟碳漆底座, 金色镀钛底脚

STRUCTURE: Top in lacquered MDF, base in metal / FINISHING: Top in lacquer, base in dark grey epoxy paint with gold titanium feet

UOVO 源
Steve Leung 梁志天



尺寸: D600*600mm
编号: 42C004

结构: 桌面为玻璃, 底座是实木 / 表面效果: 桌面是灰色玻璃, 底座为胡桃木或染色橡木

STRUCTURE: Top in glass and base in solid wood / FINISHING: Top in grey glass, and base in walnut or staine oak

CRI 可瑞
Archirivolto



尺寸: D648*449mm
编号: 41C001-03

结构: 桌面为大理石, 框架为不锈钢 / 表面效果: 桌面为中花白或杭灰大理石, 框架为香槟金镀钛不锈钢

STRUCTURE: Top in marble, stainless steel frame / FINISHING: Top in venato white marble or charly brown marble, base in champagne titanium plating stainless steel

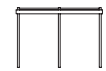

尺寸: D648*449mm
编号: 41C002-03

结构: 桌面为实木及板材贴皮, 框架为不锈钢 / 表面效果: 桌面为胡桃或染色橡木, 框架为香槟金镀钛不锈钢

STRUCTURE: Top in solid wood and veneer on particles board, stainless steel frame / FINISHING: Top in walnut or stained oak, base in champagne titanium plating stainless steel

PLUS 佳怡
Ximi Li 李希米



尺寸: D470*560mm
编号: 42C005

结构: 整体为实木和板材贴皮, 底座是不锈钢 / 表面效果: 整体为胡桃木或者染色橡木, 底座为香槟金镀钛

STRUCTURE: Whole piece in solid wood and veneer on particles board, except base in stainless steel / FINISHING: Whole piece in walnut or stained oak, except base in champagne titanium

LAYER 云层
Santiago Sevillano



尺寸: 950*450*530mm
700*475*530mm
编号: 41C008

结构: 桌面为大理石, 框架为不锈钢 / 表面效果: 桌面为中花白或杭灰大理石, 框架为香槟金镀钛

STRUCTURE: Top in marble, stainless steel frame / FINISHING: Top in venato white marble or charly brown marble, base in champagne titanium

ONA 融筑
Yonoh



尺寸: D600*488mm
D480*488mm
编号: 41C014

结构: 桌面为大理石, 层板为玻璃, 框架为金属 / 表面效果: 桌面为中花白或者杭灰大理石, 层板为灰色钢化玻璃, 框架为黑灰色氟碳漆, 立柱上下为金色镀钛装饰

STRUCTURE: Top in marble, shelf in glass and base in metal / FINISHING: Top in venato white marble or charly brown marble, shelf in grey glass, and frame in dark grey epoxy paint with gold titanium on top and feet of posts

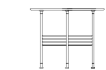

尺寸: D600*488mm
D480*488mm
编号: 41C015

结构: 桌面为实木及板材贴皮, 层板为玻璃, 框架为金属 / 表面效果: 桌面为胡桃木或染色橡木, 层板为灰色钢化玻璃, 框架为黑灰色氟碳漆, 立柱上下为金色镀钛装饰

STRUCTURE: Top in solid wood and veneer on particles board, shelf in glass and base in metal / FINISHING: Top in walnut or stained oak, shelf in grey glass, and frame in dark grey epoxy paint with gold titanium on top and feet of posts

FUGUE 富笛
Frank Chou 周宸宸



尺寸: D480*480mm
编号: 41C022

结构: 整体是实木和板材贴皮 / 表面效果: 整体为胡桃木或者染色橡木
STRUCTURE: Whole piece in solid wood and veneer on particles board / FINISHING: Whole piece in walnut or stained oak



尺寸: D480*480mm
编号: 41C021

结构: 桌面为大理石, 底部为实木 / 表面效果: 桌面为中花白或者抗灰大理石, 底部为胡桃木或者染色橡木, 或者实木黑色烤漆
STRUCTURE: Top in marble, base in solid wood / FINISHING: Top in venato white marble or charly brown marble, base in walnut or stained oak, or black lacquer

FAN
Frank Chou 周宸宸



尺寸: 470*260*555mm
编号: 42C006

结构: 桌面为大理石, 框架为不锈钢 / 表面效果: 桌面为中花白大理石, 框架为黄铜色镀钛

STRUCTURE: Top in marble, stainless steel frame / FINISHING: Top in venato white marble, base in brassy titanium

COSMO 星际
Masayuki Kurokawa 黑川雅之



尺寸: 400*400*400mm
编号: 71C001

结构: 整体金属 / 表面效果: 整体黑镜镀钛或者香槟金镀钛

STRUCTURE: Whole piece in stainless steel / FINISHING: Whole piece in black titanium or champagne titanium

CONSOLE

条案

LONJA 龙佳
Santiago Sevillano



尺寸: 1500*382*570mm
1200*382*570mm
编号: 43C001

结构: 台面为实木及板材贴皮, 框架为不锈钢 / 表面效果: 桌子为胡桃或染色橡木, 底架为香槟金镀钛

STRUCTURE: Table in solid wood and veneer on particles board, and frame in stainless steel / FINISHING: Table in walnut or stained oak, base in champagne titanium

VIVI 微微
L.L Studio



尺寸: 1500*450*570mm
1200*450*570mm
编号: 43C002

结构: 台面为烤漆密度板, 框架为不锈钢 / 表面效果: 桌面为烤漆, 底架为香槟金镀钛

STRUCTURE: Table in lacquered MDF, and frame in stainless steel / FINISHING: Top in lacquer, frame in champagne titanium

LARGO 罗曼
P&P Studio



尺寸: 1800*400*850mm
1500*400*850mm
编号: 13C001

结构: 主体为板材贴皮, 框架为不锈钢 / 表面效果: 主体为胡桃或染色橡木, 框架为黑镜镀钛

STRUCTURE: Structure in veneer on particles board, stainless steel frame / FINISHING: Structure in walnut or stained oak, frame in black titanium

GRAF 林溪
Christophe Delcourt

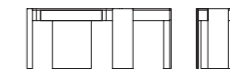

尺寸: 1800*470*750mm
1600*470*750mm
编号: 13C002

结构: 整体为实木及板材贴皮 / 表面效果: 整体为胡桃或染色橡木

STRUCTURE: Whole piece in solid wood and veneer on particles board / FINISHING: Whole piece in walnut or stained oak

LIVING CABINET

电视柜



RHYTHM 半岛
L.L Studio

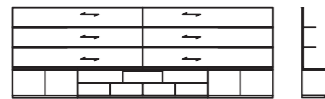

带背板 WITH BACK PANELS

尺寸: 4800*472*1664mm 4200*472*1664mm
3600*472*1664mm 3300*472*1664mm
3000*472*1664mm 2700*472*1664mm
编号: 52C004



不带背板 WITHOUT BACK PANELS

尺寸: 4200*472*528mm 3600*472*528mm
3300*472*528mm 3000*472*528mm
2700*472*528mm 2400*472*528mm
1800*472*528mm

结构: 主体为板材贴皮, 金属层板, 底柜顶面为大理石, 门板和抽屉面烤漆 / **表面效果:** 柜体和背板为胡桃或染色橡木, 背板铝合金黑丝光烤漆封边, 金属黑丝光烤漆层板, 底柜台面为中花白或者杭灰大理石, 底柜门板和抽屉面为烤漆

STRUCTURE: Structure in veneer on particles board, shelf in metal, top of bottom cabinet in marble, doors and drawer fronts in lacquered MDF / **FINISHING:** Structure and back panel in walnut or stained oak, edging in silk black lacquered aluminum alloy, shelf in silk black metal. Top of the bottom cabinet in venato white marble or charly brown marble, all doors and drawer fronts in lacquer

GRU 律动

Christophe Delcourt



尺寸: 3000*480*600mm
2400*480*600mm
1800*480*600mm
编号: 52C003

结构: 主体为板材贴皮, 把手和底座为金属 / **表面效果:** 主体为胡桃或染色橡木, 把手和底座为岩绿色烤漆

STRUCTURE: Structure in veneer on particles board, handles and base in metal / **FINISHING:** Structure in walnut or stained oak, handles and base in black green lacquered metal

GRAF 林溪

Christophe Delcourt

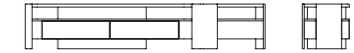

尺寸: 2800*469*450mm
2400*469*450mm
2000*469*450mm
编号: 52C002

结构: 整体为实木及板材贴皮 / **表面效果:** 整体为胡桃或染色橡木

STRUCTURE: Whole piece in solid wood and veneer on particles board / **FINISHING:** Whole piece in walnut or stained oak

LONJA 龙佳

Santiago Sevillano



尺寸: 2400*400*500mm
2000*400*500mm
编号: 52C001

结构: 主体为板材贴皮, 顶面为大理石, 底座为不锈钢 / **表面效果:** 主体为胡桃或染色橡木, 顶面为中花白或杭灰大理石, 底座为香槟金钛

STRUCTURE: Structure in veneer on particles board, top in marble, stainless steel frame / **FINISHING:** Structure in walnut or stained oak, top in venato white marble or charly brown marble, base in champagne titanium



DINING TABLE

餐桌



REMBRANT 玲珑
Achirivolto



尺寸: 2400*1100*750mm
2200*1100*750mm
2000*1100*750mm
1800*1000*750mm
1600*1000*750mm
编号: 11C013

结构: 桌面为大理石, 不锈钢底架 / 表面效果: 桌面中花白大理石或杭灰大理石, 香槟金镀钛钢架

STRUCTURE: Top in marble and frame in stainless steel / FINISHING: Top in venato white marble or charly brown marble, frame in champagne titanium plating stainless steel

MIAMI 迈阿密
Archirivolto

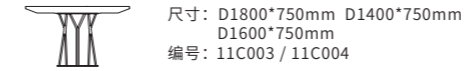

尺寸: D1800*750mm D1400*750mm
D1600*750mm
编号: 11C003 / 11C004

结构: 桌面为大理石, 或实木及板材贴皮, 底座为不锈钢与大理石 / 表面效果: 桌面可为中花白大理石、杭灰大理石、胡桃或染色橡木, 底座为香槟金镀钛。当桌面为大理石时, 底座大理石与桌面同色; 当桌面为木质时, 底座为中花白大理石

STRUCTURE: Top in marble or solid wood and veneer on particles board, base in stainless steel and marble / FINISHING: Top in venato white marble or charly brown marble, walnut or stained oak. Frame in champagne titanium. When top is in marble, the marble on the base is the same with the one on the top. And when top is in wood, the marble on the base can only be in venato white marble

FUGUE 富笛
Frank Chou 周宸宸

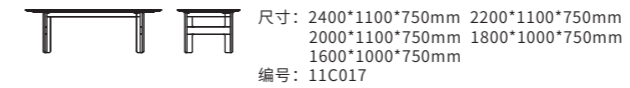

尺寸: 2400*1100*750mm 2200*1100*750mm
2000*1100*750mm 1800*1000*750mm
1600*1000*750mm
编号: 11C017

结构: 桌面为大理石, 底座为实木 / 表面效果: 桌面为中花白或者杭灰大理石, 桌腿为胡桃木或染色橡木, 或黑色烤漆实木腿

STRUCTURE: Top in marble and base in solid wood / FINISHING: Top in venato white marble or charly brown marble, frame in walnut or stained oak, or black lacquered solid wood

BRACKET 阡陌
MARIO TSAI 蔡烈超

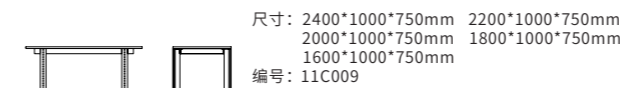

尺寸: 2400*1000*750mm 2200*1000*750mm
2000*1000*750mm 1800*1000*750mm
1600*1000*750mm
编号: 11C009

结构: 桌面为板材贴皮, 桌腿为实木 / 表面效果: 整体为胡桃或染色橡木

STRUCTURE: Top in veneer on particles board, legs in solid wood / FINISHING: Whole piece in walnut or stained oak

SIFF 江月
Christophe Delcourt

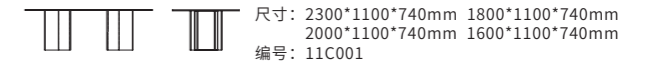
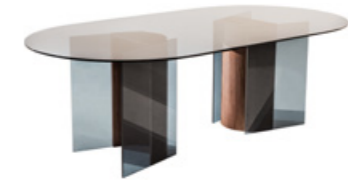

尺寸: 2300*1100*740mm 1800*1100*740mm
2000*1100*740mm 1600*1100*740mm
编号: 11C001

结构: 桌面为钢化玻璃, 底座为玻璃和板材贴皮 / 表面效果: 桌面为浅灰色玻璃, 底座为灰色玻璃和胡桃木色或染色橡木

STRUCTURE: Top in glass, base in glass and veneer on particles board / FINISHING: Top in gray glass, base in gray glass and walnut or stained oak

FIKA 贝加
Frank Chou 周宸宸

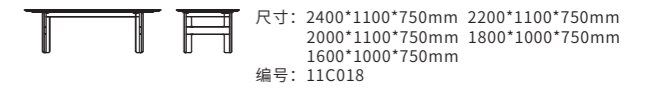

尺寸: 2400*1100*750mm 2200*1100*750mm
2000*1100*750mm 1800*1000*750mm
1600*1000*750mm
编号: 11C018

结构: 桌面为实木及板材贴皮, 实木开孔漆腿 / 表面效果: 整体为胡桃木或染色橡木

STRUCTURE: Whole piece in solid wood and veneer on particles board / FINISHING: Whole piece in walnut or stained oak

FIKA 贝加
Frank Chou 周宸宸

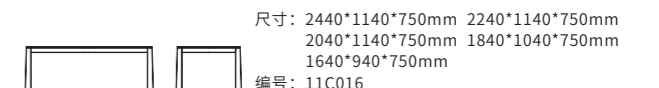

尺寸: 2440*1140*750mm 2240*1140*750mm
2040*1140*750mm 1840*1040*750mm
1640*940*750mm
编号: 11C016

结构: 桌面为板材贴皮, 桌腿为实木 / 表面效果: 整体为胡桃或染色橡木色橡木

STRUCTURE: Top in veneer on particles board, legs in solid wood / FINISHING: Whole piece in walnut or stained oak

FLU 芙蓉
Achirivolto



尺寸: 2400*1100*750mm 2200*1100*750mm
2000*1100*750mm 1800*1000*750mm
1600*1000*750mm
编号: 11C015

结构: 桌面为实木及板材贴皮, 实木腿 / 表面效果: 桌面为胡桃木或染色橡木, 烤漆实木腿

STRUCTURE: Top in solid wood and veneer on particles board, and legs in solid wood / FINISHING: Top in walnut or stained oak, legs in lacquered solid wood



尺寸: 2400*1100*750mm 2200*1100*750mm
2000*1100*750mm 1800*1000*750mm
1600*1000*750mm
编号: 11C014

结构: 桌面为大理石, 实木腿 / 表面效果: 桌面中花白大理石或杭灰大理石、实木腿烤漆

STRUCTURE: Top in marble, and legs in solid wood / FINISHING: Top in venato white marble or charly brown marble, legs in lacquered solid wood

UOVO 源
Steve Leung 梁志天



尺寸: D1800*750mm D1600*750mm
D1400*750mm
编号: 11C005

结构: 桌面为实木及板材贴皮, 桌腿为实木, 转盘为木质烤漆、大理石或毛毡饰面 / 表面效果: 桌面和桌腿为胡桃或染色橡木, 转盘为木质烤漆、中花白或杭灰大理石、黑色或灰色毛毡饰面

STRUCTURE: Whole piece in solid wood and veneer on particles board, legs in solid wood, and turnplate in lacquer, marble or linoleum / FINISHING: Whole piece in walnut or stained oak, except turnplate in lacquer, venato white marble or charly brown marble, black or grey linoleum



尺寸: D1000*750mm
编号: 11C008

结构: 桌面和立柱烤漆密度板, 金属底座 / 表面效果: 桌面和立柱为白色烤漆时, 底座为金属白色烤漆; 桌面和立柱为砚灰色烤漆时, 底座为黑灰色氟碳漆

STRUCTURE: Top and leg in lacquered MDF, base in metal / FINISHING: When top and leg in white lacquer, base in white lacquered metal; when top and leg in rock grey lacquer, base in dark grey epoxy paint



CHAIR

椅子



CHIP 齐贝
Yonoh



尺寸: 539*525*772mm
编号: 21F010

结构: 框架为金属, 主体 PU 发泡一次成型, 椅腿为金属 / 表面效果: 软包不可拆卸, 多种面料或牛皮可选, 椅腿为黑灰色氟碳漆, 金色地脚

STRUCTURE: Structure in metal and shaped polyurethane foam, legs in metal / FINISHING: Upholstered with non-removable covering in fabric or leather, legs in dark grey epoxy paint, feet in gold titanium stainless steel,

LEIF 林风
Francois Champsaur



尺寸: 494*487*765mm
编号: 21F011

结构: 主体为多层板, 椅腿为实木 / 表面效果: 软包不可拆卸, 多种面料或牛皮可选, 椅腿为胡桃或染色橡木

STRUCTURE: Structure in plywood, legs in solid wood / FINISHING: Upholstered with non-removable covering in fabric or leather, legs in walnut or stained oak,

LIME 琳云
Archirivolto



尺寸: 490*650*895mm
编号: 21F009

结构: 主体为多层板, 椅腿为金属 / 表面效果: 软包不可拆卸, 多种面料或牛皮可选, 椅腿为黑灰色氟碳漆

STRUCTURE: Structure in plywood, legs in metal / FINISHING: Upholstered with non-removable covering in fabric or leather, legs in dark grey epoxy paint

NAO 尼奥
Archirivolto



尺寸: 446*568*810mm
编号: 21F008

结构: 主体为多层板, 椅腿为实木 / 表面效果: 软包不可拆卸, 多种面料或牛皮可选, 椅腿为胡桃或染色橡木

STRUCTURE: Structure in plywood, legs in solid wood / FINISHING: Upholstered with non-removable covering in fabric or leather, legs in walnut or stained oak

ENCONTRA 轻舟
L.L Studio



尺寸: 500*590*850mm
编号: 21F005

结构: 主体为多层板, 椅腿为实木 / 表面效果: 软包不可拆卸, 多种面料或牛皮可选, 椅腿为胡桃或染色橡木

STRUCTURE: Structure in plywood, legs in solid wood / FINISHING: Upholstered with non-removable covering in fabric or leather, legs in walnut or stained oak

MONCLER 羽容
Archirivolto



尺寸: 457*562*850mm
编号: 21F007

结构: 主体为多层板, 椅腿为金属 / 表面效果: 软包不可拆卸, 多种面料或牛皮可选, 椅腿为黑灰色氟碳漆

STRUCTURE: Structure in plywood, legs in metal / FINISHING: Upholstered with non-removable covering in fabric or leather, legs in dark grey epoxy paint

HOME 依恋
Yonoh



尺寸: 485*575*783mm
编号: 21F002

结构: 主体为多层板, 椅腿为金属 / 表面效果: 软包不可拆卸, 多种面料可选, 面料软包配黑色滚边线, 椅腿为金属黑色丝光烤漆, 金色地脚

STRUCTURE: Structure in plywood, legs in metal / FINISHING: Upholstered with non-removable covering in fabric, matching with black piping line, legs in silk black lacquered metal, feet in gold titanium stainless steel

UOVO 源
Steve Leung 梁志天



尺寸: 660*630*650mm
编号: 22F001

结构: 主体为多层板, 椅腿为实木 / **表面效果:** 软包不可拆卸, 多种面料或牛皮可选, 椅腿为胡桃或染色橡木

STRUCTURE: Structure in plywood, legs in solid wood / **FINISHING:** Upholstered with non-removable covering in fabric or leather, legs in walnut or stained oak

OHO 燕亭
Christophe Delcourt



尺寸: 500*580*800mm
编号: 21F001

结构: 主体为多层板, 椅腿为实木 / **表面效果:** 软包不可拆卸, 多种面料或牛皮可选, 椅腿为胡桃或染色橡木

STRUCTURE: Structure in plywood, legs in solid wood / **FINISHING:** Upholstered with non-removable covering in fabric or leather, legs in walnut or stained oak

PULO 布丁
Archirivolto

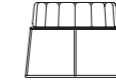

尺寸: D600*450mm
D500*500mm
编号: 23F001

结构: 主体为多层板, 底架为金属 / **表面效果:** 软包不可拆卸, 多种面料或牛皮可选, 底脚为金属黑丝光烤漆或香槟金镀钛

STRUCTURE: Structure in plywood, base in metal / **FINISHING:** Upholstered with non-removable covering in fabric or leather, base in silk black lacquered metal or champagne titanium

LONJA 龙佳
Santiago Sevillano

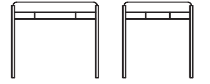

尺寸: 516*416*450mm
编号: 23F002

结构: 主体为多层板, 不锈钢框架 / **表面效果:** 主体为软包面料或皮, 底座为不锈钢香槟金镀钛

STRUCTURE: Structure in plywood, legs in stainless steel / **FINISHING:** Upholstered with fabric or leather, base in champagne titanium plating stainless steel

TONO 合生
Yonoh



尺寸: 600*570*770mm
编号: 21F004

结构: 主体为多层板, 椅腿为实木 / **表面效果:** 软包不可拆卸, 多种面料或牛皮可选, 椅腿为胡桃或染色橡木

STRUCTURE: Structure in plywood, legs in solid wood / **FINISHING:** Upholstered with non-removable covering in fabric or leather, legs in walnut or stained oak

BOLA 飞燕
Yonoh



尺寸: 600*560*775mm
编号: 21F003

结构: 主体为多层板, 椅腿为金属 / **表面效果:** 软包不可拆卸, 多种面料可选, 椅腿为金属黑色丝光烤漆, 金色地脚

STRUCTURE: Structure in plywood, legs in metal / **FINISHING:** Upholstered with non-removable covering in fabric, metal legs in silk black lacquered metal, feet in gold titanium stainless steel

HAT 帽椅
MARIO TSAI 蔡烈超



尺寸: 576*555*755mm
编号: 21F006

结构: 主体为实木弯曲框架 / **表面效果:** 软包不可拆卸, 多种面料或牛皮可选, 框架为胡桃或染色橡木

STRUCTURE: Structure in bent solid wood and plywood / **FINISHING:** Upholstered with non-removable covering in fabric or leather, legs in walnut or stained oak



SIDEBOARD

餐边柜



GRU 律动
Christophe Delcourt

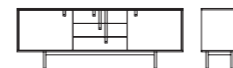

尺寸: 2100*480*800mm
1800*480*800mm
编号: 51C002

结构: 主体为板材贴皮, 把手和底座为金属 / 表面效果: 主体为胡桃或染色橡木, 把手和底座为金属岩绿烤漆

STRUCTURE: Structure in veneer on particles board, handles and base in metal / FINISHING: Structure in walnut or stained oak, handles and base in black green lacquered metal

GRAPHIC 平川
P&P Studio



尺寸: 2158*450*730mm
1858*450*730mm
编号: 51C005

结构: 主体为板材贴皮, 门板为烤漆, 底座为金属 / **表面效果:** 主体为胡桃或染色橡木, 门板为条纹岩绿烤漆, 底座为金属黑丝光烤漆

STRUCTURE: Structure in veneer on particles board, doors in lacquered MDF, base in metal / **FINISHING:** Structure in walnut or stained oak, doors in striped black green lacquer, base in silk black lacquered metal



尺寸: 1106*450*1255mm
编号: 51C006

结构: 主体为板材贴皮, 门板为烤漆, 底座为金属 / **表面效果:** 主体为胡桃或染色橡木, 门板为条纹岩绿烤漆, 底座为金属黑丝光烤漆

STRUCTURE: Structure in veneer on particles board, doors in lacquered MDF, base in metal / **FINISHING:** Structure in walnut or stained oak, doors in striped black green lacquer, base in silk black lacquered metal

LONJA 龙佳
Santiago Sevillano



尺寸: 2200*450*800mm
2000*450*800mm
编号: 51C001

结构: 主体为板材贴皮, 顶面为大理石, 框架为不锈钢 / **表面效果:** 主体为胡桃或染色橡木, 顶面为中花白或杭灰大理石, 底架为香槟金镀钛

STRUCTURE: Structure in veneer on particles board, top in marble, stainless steel frame / **FINISHING:** Structure in walnut or stained oak, top in venato white marble or charly brown marble, base in champagne titanium

GRAF 林溪
Christophe Delcourt



尺寸: 2200*469*750mm
2000*469*750mm
1800*469*750mm
编号: 51C008

结构: 整体为实木及板材贴皮 / **表面效果:** 整体为胡桃或染色橡木

STRUCTURE: Whole piece in solid wood and veneer on particles board / **FINISHING:** Whole piece in walnut or stained oak

LARGO 罗曼
P&P Studio



尺寸: 2000*500*750mm
1800*500*750mm
1500*500*750mm
编号: 51C004

结构: 主体为板材贴皮, 底座为不锈钢 / **表面效果:** 主体为胡桃或染色橡木, 底架为黑镜镀钛

STRUCTURE: Structure in veneer on particles board, base in stainless steel / **FINISHING:** Structure in walnut or stained oak, base in black titanium

LONJA 龙佳
Santiago Sevillano



尺寸: 2200*466*862mm
1800*466*862mm
1600*466*862mm
编号: 51C003

结构: 主体为板材贴皮, 顶面为大理石, 框架为不锈钢 / **表面效果:** 主体为胡桃或染色橡木, 顶面为中花白或杭灰大理石, 底架为香槟金镀钛

STRUCTURE: Structure in veneer on particles board, top in marble, stainless steel frame / **FINISHING:** Structure in walnut or stained oak, top in venato white marble or charly brown marble, base in champagne titanium

CRESTA 叠章
Yonoh



尺寸: 2000*550*750mm
编号: 51C007

结构: 主体为板材贴皮, 底架为金属带大理石层板, 抽屉面板或门板为板材贴皮或烤漆密度板 / **表面效果:** 柜体为胡桃或染色橡木, 两块门板和抽屉面为胡桃或染色橡木, 另两块条纹岩绿烤漆门板位置固定不变, 底架为金属黑丝光烤漆, 层板为中花白大理石

STRUCTURE: Structure in veneer on particles board, drawer fronts and doors in veneer on particle board or lacquered MDF, base in metal with marble shelf / **FINISHING:** Structure in walnut or stained oak, drawer fronts and two doors in walnut or stained oak, another two doors in striped black green lacquer, metal base in silk black lacquer, shelf in venato white marble

RITA 瑞达
L.L Studio



尺寸: 2400*500*800mm
2000*500*800mm
1810*500*800mm
编号: 51C009

结构: 主体为板材贴皮, 金属底架 / **表面效果:** 柜体外侧为胡桃或染色橡木, 内侧为拉丝白橡, 底架为灰黑色氟碳漆

STRUCTURE: Structure in veneer on particles board, base in metal / **FINISHING:** Structure in walnut or stained oak, inner panels in brushed white oak, metal base in dark grey epoxy paint

结构: 主体为板材贴皮, 金属底架 / **表面效果:** 柜体为胡桃或染色橡木, 上层开放部分带有烤漆内盒和镜子, 金属黑灰氟碳漆底架

STRUCTURE: Structure in veneer on particles board, base in metal / **FINISHING:** Structure in walnut or stained oak, and lacquered tray and mirror included in the top opening, metal base in dark grey epoxy paint



BED & BEDSIDE TABLE

床 & 床头柜



UOVO 源
Steve Leung 梁志天

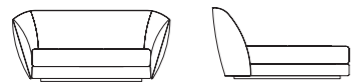

尺寸: 2550*2285*1080mm (床垫 2000*2000mm) 2350*2285*1080mm (床垫 1800*2000mm)
2150*2285*1080mm (床垫 1600*2000mm) 2050*2285*1080mm (床垫 1500*2000mm)
编号: 61F002

床头: 面料或牛皮软包床头 / 结构: 框架为实木与多层板结构, 底脚为实木开孔漆

HEADBOARD: Upholstered with fabric or leather / STRUCTURE: Structure in solid wood and plywood, feet in walnut or stained oak

CITTI 西提
Frank Chou 周宸宸

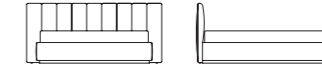

尺寸: 2250*2175*1040mm (床垫 2000*2000mm)
2250*2175*1040mm (床垫 1800*2000mm)
2000*2175*1040mm (床垫 1600*2000mm)
2000*2175*1040mm (床垫 1500*2000mm)
1500*2175*1040mm (床垫 1200*2000mm)
编号: 61F001

床头: 面料或牛皮软包床头 / 结构: 框架为实木与多层板结构, 气动床箱, 床围底座木质金色烤漆

HEADBOARD: Upholstered with fabric or leather / STRUCTURE: Structure in solid wood and plywood, pneumatic trunk-bed, wood base in gold lacquer

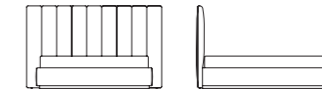

尺寸: 2500*2175*1300mm (床垫 2000*2000mm)
2250*2175*1300mm (床垫 1800*2000mm)
2000*2175*1300mm (床垫 1600*2000mm)
2000*2175*1300mm (床垫 1500*2000mm)
1500*2175*1300mm (床垫 1200*2000mm)
编号: 61F007

床头: 面料或牛皮软包床头 / 结构: 框架为实木与多层板结构, 气动床箱, 床围底座木质金色烤漆

HEADBOARD: Upholstered with fabric or leather / STRUCTURE: Structure in solid wood and plywood, pneumatic trunk-bed, wood base in gold lacquer

HAP 哈伯
Christophe Delcourt



尺寸: 2200*2184*1080mm (床垫 2000*2000mm)
2000*2184*1080mm (床垫 1800*2000mm)
1800*2184*1080mm (床垫 1600*2000mm)
1700*2184*1080mm (床垫 1500*2000mm)
编号: 61F005

床头: 面料或牛皮软包床头, 内侧和外侧的选择可不同 / 结构: 框架为实木与多层板结构, 床围底座木质金色烤漆

HEADBOARD: Upholstered with fabric or leather and the options can be different for inside and outside of the headboard / STRUCTURE: Structure in solid wood and plywood, wood base in gold lacquer

LONJA 龙佳
Santiago Sevillano



床头：面料或牛皮软包床头 / 结构：底脚为金色镀钛不锈钢，框架为实木与多层板结构

带床尾板 WITH FOOTBOARD

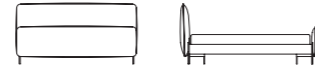

尺寸：2210*2270*1100mm (床垫 2000*2000mm)
2010*2270*1100mm (床垫 1800*2000mm)
1810*2270*1100mm (床垫 1600*2000mm)
1710*2270*1100mm (床垫 1500*2000mm)
编号：61F003

无床尾板 WITHOUT FOOTBOARD

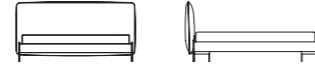

编号：61F008

HEADBOARD: Upholstered with fabric or leather / STRUCTURE: Structure in solid wood and plywood, legs in champagne titanium plating stainless steel

FUGUE 富笛
Frank Chou 周宸宸



床头：面料或牛皮软包床头 / 结构：框架为实木与多层板结构，金属黑丝光烤漆腿

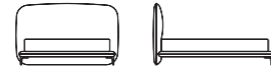

尺寸：2320*2260*1150mm (床垫 2000*2000mm)
2120*2260*1150mm (床垫 1800*2000mm)
1920*2260*1150mm (床垫 1600*2000mm)
1820*2260*1150mm (床垫 1500*2000mm)
编号：61F006

HEADBOARD: Upholstered with fabric or leather / STRUCTURE: Structure in solid wood and plywood, legs in silk black lacquered metal

ANNI 悠然
L.L Studio



尺寸：D500*550mm
编号：53C002

结构：框架为弯曲木贴皮，顶部和抽屉面为烤漆密度板 / 表面效果：框架为胡桃或染色橡木，顶部和抽屉面为烤漆

STRUCTURE: Structure in veneer on bent wood, top and drawer front in lacquered MDF / FINISHING: Structure in walnut or stained oak, top and drawer front in lacquer

GRAF 林溪
Christophe Delcourt



尺寸：600*450*500mm
编号：53C001

结构：整体为实木及板材贴皮 / 表面效果：整体为胡桃或染色橡木
STRUCTURE: Whole piece in solid wood and veneer on particles board / FINISHING: Whole piece in walnut or stained oak

GRU 律动
Christophe Delcourt



尺寸：700*480*600mm
600*480*600mm
编号：53C003

结构：主体为实木及板材贴皮，拉手及底架为金属 / 表面效果：主体为胡桃或染色橡木，把手及底架为岩绿色金属烤漆

STRUCTURE: Whole piece in solid wood and veneer on particles board, handles and base in metal / FINISHING: Structure in walnut or stained oak, handles and base in black green lacquered metal

RITA 瑞达
L.L Studio



尺寸：700*480*550mm
600*480*550mm
编号：53C007

结构：主体板材贴皮，顶面实木围边，底架金属 / 表面效果：整体为胡桃或染色橡木，顶面嵌入马鞍皮，底架黑灰色氟碳漆

STRUCTURE: Structure in veneer on particles board, top edging in solid wood, and frame in metal / FINISHING: Structure and top edging in walnut or stained oak, top covered with saddle leather and frame in dark grey epoxy paint

LONJA 龙佳
Santiago Sevillano



尺寸：516*466*540mm
编号：53C005/53C004

结构：主体板材贴皮，抽屉面为烤漆密度板或板材贴皮，框架不锈钢 / 表面效果：整体为胡桃木或染色橡木，抽屉面为烤漆或胡桃木或染色橡木，框架为香槟金镀钛

STRUCTURE: Structure in veneer on particles board, drawer fronts in MDF or veneer on particles board, frame in stainless steel / FINISHING: Structure in walnut or stained oak, drawer fronts in lacquer, or walnut or stained oak, and frame in champagne titanium

BELLA 贝拉
L.L Studio



尺寸：700*495*500mm
编号：53C008

结构：整体板材贴皮 / 表面效果：整体为胡桃木或染色橡木，顶面为马鞍皮，产品圆角分左右，图片中的为左

STRUCTURE: Whole piece in veneer on particles board / FINISHING: Whole piece in walnut or stained oak, and top in saddle leather. Rounded corner on left or right side, the one in the picture is on the left

LONJA 龙佳
Santiago Sevillano



尺寸: 1300*450*1270mm
编号: 14C002

结构: 主体为板材贴皮, 框架为不锈钢 / **表面效果:** 桌子为胡桃或染色橡木, 底架和镜框为香槟金镀钛

STRUCTURE: Table in veneer on particles board, base and mirror frame in stainless steel / **FINISHING:** Table in walnut or stained oak, base and mirror frame in champagne titanium

LONJA 龙佳
Santiago Sevillano



尺寸: 622*466*1620mm
编号: 14C003

结构: 主体为板材贴皮, 底架和镜框为不锈钢 / **表面效果:** 主体为胡桃或染色橡木, 底架和镜框为香槟金镀钛

STRUCTURE: Structure in veneer on particles board, base and mirror frame in stainless steel / **FINISHING:** Structure in walnut or stained oak, base and mirror frame in champagne titanium

LARGO 罗曼
P&P Studio



尺寸: 1200*450*1270mm
1000*450*1270mm
编号: 14C001

结构: 主体和镜面为板材贴皮, 框架为不锈钢 / **表面效果:** 主体和镜框为胡桃或染色橡木, 框架为黑镜镀钛

STRUCTURE: Structure in veneer on particles board, base in stainless steel / **FINISHING:** Mirror frame and table top in walnut or stained oak, base in black titanium

PLUS 佳怡
Ximi Li 李希米



尺寸: 480*470*1270mm
编号: 53C006

结构: 整体为实木及板材贴皮, 框架为不锈钢 / **表面效果:** 整体为胡桃或染色橡木, 框架为黑镜镀钛或香槟金镀钛

STRUCTURE: Whole piece in solid wood and veneer on particles board, except frame in stainless steel / **FINISHING:** Whole piece in walnut or stained oak, frame in black or champagne titanium

BELLA 贝拉
L.L Studio

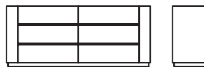

尺寸: 1906*450*800mm
1506*450*800mm
编号: 52C005

结构: 主体为板材贴皮 / **表面效果:** 整体胡桃木或者染色橡木, 面板贴马鞍皮, 六个抽屉

STRUCTURE: Whole piece in veneer on particles board / **FINISHING:** Whole piece in walnut or stained oak, top of the cabinet in saddle leather, totally six drawers

LONJA 龙佳
Santiago Sevillano

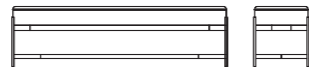

尺寸: 1816*416*450mm
1616*416*450mm
编号: 24F001

结构: 主体为多层板, 不锈钢框架 / **表面效果:** 主体为软包面料, 底座为不锈钢香槟金镀钛

STRUCTURE: Structure in plywood, legs in stainless steel / **FINISHING:** Upholstered with fabric, base in champagne titanium plating stainless steel

DESK & BOOKCASE

书桌 & 书架

UO 优沃
Hi Thanks Bye



尺寸: 610*619*1788mm
编号: 71C008

结构: 搁架前板和背板为烤漆密度板, 中层置物架和框架为金属 / **表面效果:** 整体岩绿色烤漆

STRUCTURE: Front and back panels are lacquered MDF, shelf and base in metal / **FINISHING:** Whole piece in dark green lacquer

LONJA 龙佳
Santiago Sevillano

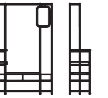

尺寸: 1184*414*1820mm
编号: 56C001

结构: 整体框架和底层层板为香槟金镀钛不锈钢, 中间条几为胡桃木或者染色橡木, 包含软包面料或皮质坐垫。左侧中花白大理石托盘, 右侧挂镜香槟金镀钛不锈钢镶边 / **表面效果:** 整体框架和底层层板为香槟金镀钛不锈钢, 中间条几为胡桃木或者染色橡木, 包含软包面料或皮质坐垫。左侧中花白大理石托盘, 下方另有胡桃木或染色橡木储物盒, 右侧挂镜香槟金镀钛不锈钢镶边。

STRUCTURE: Whole frame and bottom shelf in champagne titanium, bench in walnut or stained oak with seat cushion in fabric or leather, tray on the left in venato white marble, and hanging mirror with champagne titanium frame / **FINISHING:** Whole frame and bottom shelf in champagne titanium, bench in walnut or stained oak with seat cushion in fabric or leather, tray in venato white marble, wood box underneath in walnut or stained oak, and hanging mirror with champagne titanium frame

GRAF 林溪
Christophe Delcourt

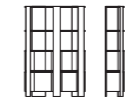

尺寸: 1200*370*1800mm
编号: 55C001

结构: 整体为实木及板材贴皮 / **表面效果:** 整体为胡桃或染色橡木

STRUCTURE: Whole piece in solid wood and veneer on particles board / **FINISHING:** Whole piece in walnut or stained oak

RHYTHM 半岛
L.L Studio

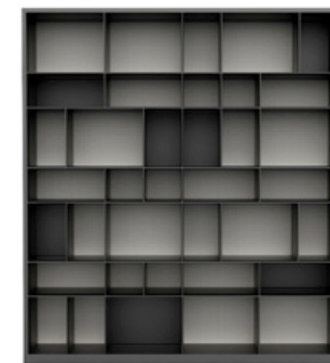

组合尺寸: 2374*357*2697mm
3238*357*2697mm
3526*357*2697mm
4102*357*2697mm
4390*357*2697mm
4678*357*2697mm

2374*357*2401mm
3238*357*2401mm
3526*357*2401mm
4102*357*2401mm
4390*357*2401mm
4678*357*2401mm

2374*357*1975mm
3238*357*1975mm
3526*357*1975mm
4102*357*1975mm
4390*357*1975mm
4678*357*1975mm

编号: 55C002

结构: 整体为实木和密度板 / **表面效果:** 整体为哑光烤漆, 除背板为白色哑光烤漆

STRUCTURE: Whole piece in solid wood and MDF / **FINISHING:** Whole piece in rock grey lacquer, except back panel in matt white lacquer

LARGO 罗曼
P&P Studio



结构: 主体为板材贴皮, 框架为不锈钢 / 表面效果: 主体为胡桃或染色橡木, 框架为黑镜镀钛
STRUCTURE: Structure in veneer on particles board, stainless steel frame / FINISHING: Structure in walnut or stained oak, frame in black titanium



尺寸: 1600*600*760mm
1400*600*760mm
1200*600*760mm
编号: 12C001

ACCESSORY 配饰

ILLUSION 叠影
MARIO TSAI 蔡烈超



尺寸: 450*450*1500mm
编号: 72C001

表面效果: 整体香槟金镀钛不锈钢
FINISHING: Whole piece in champagne titanium plating stainless steel

FLYING MIRROR 飞镜
MARIO TSAI 蔡烈超



尺寸: 600*400*50mm
编号: 71C003

表面效果: 镜面和香槟金镀钛不锈钢
FINISHING: Mirror with champagne titanium plating stainless steel



尺寸: 500*550*50mm
编号: 71C004

表面效果: 镜面和香槟金镀钛不锈钢
FINISHING: Mirror with champagne titanium plating stainless steel

RUG
地毯

CORNICE 漫步
Claire Vos



尺寸: 4500*3442mm
4000*3060mm
3500*2612mm
3200*2326mm
编号: DCA99

表面效果: 新西兰羊毛加丝
FINISHING: New Zealand wool with silk

HALO 追光者
Claire Vos

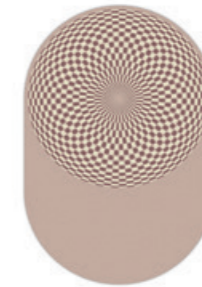

尺寸: 4500*3000mm
4000*2667mm
3500*2334mm
3200*2134mm
编号: DCA100

表面效果: 100% 新西兰羊毛
FINISHING: 100% New Zealand wool

TUMBLE 探帛
Claire Vos



尺寸: 4500*3015mm
4000*2670mm
3500*2345mm
3200*2144mm
编号: DCA101

表面效果: 100% 新西兰羊毛
FINISHING: 100% New Zealand wool

HC28 Cosmo

电话 / 010-85262862-828

传真 / 010-85262780

2019年9月出版印刷, 版权所有, 侵权必究

商品信息以门店咨询为准

hc28.com.cn

T/ +86-10-85262862-828

F/ +86-10-85262780

PRINTED: september 2019 copyright hc28 cosmopolitan

all rights reserved, any reproduction, representation or

modification, in full or partly, is expressly prohibited.

For the accurate information, please consult the shop

staff.

hc28.com.cn

HC28 Cosmo

hc28.com.cn